

Ozone Monitor



OPERATION MANUAL

**Models 106-M and OEM-106-M
Multi-Channel Models 106-M-MC3 and 106-M-MC6**

© Copyright 2024, 2B Technologies
All rights reserved.

Technical Support:
<https://2btech.io/support/>
techsupport@2btech.io
+1(303)273-0559

Contents

IDENTIFICATION RECORDS	iv
PRINTING HISTORY	v
WARRANTY STATEMENT	vi
WARNINGS	viii
1. OZONE MONITOR INTRODUCTION	1
1.1 Theory of Operation.....	1
1.2 Calibration Overview	3
1.3 The DewLine™.....	3
1.4 Adaptive Filter.....	4
2. SPECIFICATIONS: Model 106-M and OEM-106-M Ozone Monitor	5
3. OPERATION	6
3.1 Shipping Box Contents.....	6
3.2 Operation of the Ozone Monitor	6
3.2.1 Overview	6
3.2.2 Operating Recommendations	8
3.3 The LCD Menu	9
3.4 Selecting the Main Menu	10
3.5 Making Measurements without Averaging or Logging	10
3.6 Data Averaging and Data Logging Using the Menu	11
3.6.1 To Average the Data without Logging.....	11
3.6.2 To Log Data.....	11
3.7 To Stop Logging Data.....	12
3.8 To Set the Time and Date	12
3.9 To Change the Ozone, Temperature, and Pressure Measurement Units	13
3.10 Measurement of the Zero Offset	13
3.11 To Set the Calibration Parameters	13
3.12 Collecting Data over the USB or Serial Port in Real Time	15
3.12.1 Data Acquisition Software	15
3.12.2 Determine the Connection Port and Baud Rate Settings	16
3.12.3 Data Output.....	16
3.13 To Change the Baud Rate.....	17
3.14 To Transmit Logged Data to a Computer Using the USB or Serial Port	17
3.15 Accessing the Serial Menu and the USB Menu	17
3.16 Collecting Data from the Analog Output.....	19
3.17 To Read the Number of Hours of Ozone Monitor Use	19
3.18 Using and Setting the Relay Limits	19
3.19 Lamp Test.....	20
3.20 LED Indicator Lights	21
4. MAINTENANCE/TROUBLESHOOTING	22
4.1 Overview.....	22
4.2 Maintenance Recommendations.....	23
4.3 Troubleshooting.....	23
5. CALIBRATION	26

5.1	Overview.....	26
5.2	Equipment Required.....	27
5.3	Instrument Preparation.....	27
5.4	Calibration Setup Preparation.....	27
5.4.1	Setup Check.....	28
5.4.2	Ozone Loss Test.....	28
5.4.3	Linearity Check.....	28
5.4.4	Intercomparison Test.....	29
5.5	Calibration Procedure.....	29
5.5.1	Instrument Preparation.....	29
5.5.2	Measurement of Zero Air.....	29
5.5.3	Measurement of Ozone Standards.....	30
5.5.4	Calibration Curve.....	30
6.	PERIODIC ZERO AND SPAN CHECKS	31
7.	LABELED INSTRUMENT PHOTOS	32
8.	PARTS LIST	36
9.	SERVICE LOG	37
	Appendix A: Using the 2B Technologies Display and Graphing Software	39
	Appendix B: Model 106-M Cleaning Procedures (Flow Path)	43
	Appendix C: Installation and Use of the USB Connection (for older versions of the Model 106 and/or Windows)	51
	Appendix D: Operation of the Multi-Channel Model 106-M Ozone Monitor	55
D.1	Introduction.....	55
D.2	Specifications of Model 106-M-MC3 and Model 106-M-MC6.....	56
D.3	Installation and Startup.....	57
D.4	Summary of Operating Recommendations.....	60
D.5	The LCD Display During Measurements.....	61
D.6	LCD Menu Operation.....	62
D.6.1	The LCD Menu Tree.....	62
D.6.2	The Multi-Channel Submenu (Mch).....	63
D.6.3	Other LCD Menu Functions.....	64
D.7	Relays.....	64
D.8	Using the Serial Connection.....	64
D.9	LED Indicator Lights.....	67
D.10	Other Aspects Regarding Operation of the Multi-Channel Model 106-M.....	67
D.11	Maintenance/Troubleshooting, Calibration, and Zero/Span Checks.....	67
D.12	Labeled Instrument Photos.....	68
	Appendix E: Mounting the OEM Model 106 Ozone Monitor	72

IDENTIFICATION RECORDS

Record the following information for future reference:

Unit serial number: _____

Warranty start date: _____
(date of receipt)

PRINTING HISTORY

This manual covers the Model 106-M Ozone Monitor used for measurement of Medium ozone concentrations in air over a wide dynamic range extending from 10 parts-per-billion by volume (ppb) to an upper limit of 1000 parts-per-million (ppm). It also covers the NEMA 4X Industrial enclosure which offers multi-channel versions of the Model 106 (see Appendix D) and the Model OEM-106-M Ozone Monitor, which does not have an enclosure and can be used for Original Equipment Manufacturer (OEM) applications. New editions of this manual are complete revisions that reflect updates to the instrument itself, as well as clarifications, additions, and other modifications of the text.

Revision A.....	October 2009
Revision B.....	December 2009
Revision C	September 2010
Revision D	January 2013
Revision E (serial no. 1004M and above).....	February 2017
Revision E-2 (serial no. 1004M and above).....	May 2018
<i>Addition of Appendix D describing the Multi-Channel Option, and corresponding edits to main manual. Other clarifications to text of main manual.</i>	
Revision E-3 (serial no. 1004M and above).....	November 2018
<i>Updated website links; updated schematic in Section 1.1; other minor edits to text.</i>	
Revision E-4 (serial no. 1004M and above).....	December 2019
<i>Added recommendation to avoid corrosives from ozone generators (Sections 3.2, Appendix D: D.3 and D.4); added note in Appendix A about our new video tutorial on using 2B Data Display, and note about the necessary language setting for the computer that is using 2B Data Display.</i>	
Revision F-1 (serial no. 1004M and above).....	August 2020
<i>Photo updates in Section 7 to reflect stainless steel inlet fitting. Updated Appendix D to describe the Industrial Multi-Channel that has replaced the NEMA.</i>	
Revision F-2 (serial no. 1004M and above).....	September 2020
<i>Addition of Appendix E about installation of the 106-OEM. Add exhaust filter. Other minor edits.</i>	
Revision F-3 (serial no. 1004M and above).....	April 2021
<i>Update photo 7.1b of the OEM in Section 7. Update part numbers in Section 8. Add Exhaust Port option to Section 2 specs table. Updates to Appendix D regarding NEMA 4X installation. Minor edits.</i>	
Revision F-4 (serial no. 1004M and above).....	May 2021
<i>New photos 7.2b and 7.3b of the OEM-106-M in Section 7.</i>	
Revision F-5 (serial no. 1004M and above).....	March 2023
<i>Clarifications to Section 3.2.1 that the sample air pulled in by the internal pump is vented to the inside of the Model 106M enclosure, and about minimizing inlet tubing length to maintain pump performance.</i>	
Revision F-6 (serial no. 1390M and above).....	June 2023
<i>Modification to serial menu for factory temperature sensor settings. Add corrosion resistance as an option in Specifications table.</i>	
Revision F-7 (serial no. 1390M and above).....	November 2023
<i>Updated hyperlinks. Updated wiring label in Appendix D, Figures D-7, D-8a, D-8b.</i>	
Revision F-8 (serial no. 1390M and above).....	January 2024
<i>Updated Section 3.2 and D.3 to add warning about not pressurizing the inlet of the instrument.</i>	

TRADEMARKS & PATENTS

2B Technologies™, 2B Tech™, 2B™, and Ozone Monitor™ are trademarks of 2B Technologies.

CONFIDENTIALITY

The information contained in this manual may be confidential and proprietary and is the property of 2B Technologies. Information disclosed herein shall not be used to manufacture, construct, or otherwise reproduce the goods disclosed herein. The information disclosed herein shall not be disclosed to others or made public in any manner without the expressed written consent of 2B Technologies.

© Copyright 2024, 2B Technologies. All rights reserved.

WARRANTY STATEMENT

2B Technologies warrants its products against defects in materials and workmanship. 2B Technologies will, at its option, repair or replace products that prove to be defective. The warranty set forth is exclusive and no other warranty, whether written or oral, is expressed or implied. 2B Technologies specifically disclaims the implied warranties of merchantability and fitness for a particular purpose.

Warranty Periods

The warranty period is one (1) year from date of receipt by the purchaser, but in no event more than thirteen (13) months from original invoice date from 2B Technologies.

Warranty Service

Warranty Service is provided to customers via web ticket, email, and phone support, Monday - Friday, from 9:00 a.m. to 5:00 p.m., Mountain Time USA. The preferred method of contacting us is through our web ticketing software at:

<https://2btech.io/support/>

This way all technical staff at 2B Tech will be alerted of your problem and be able to respond. When you receive an email reply, please click on the Ticket link provided to continue to communicate with us directly over the internet. The web ticket approach to customer service allows us to better track your problem and be certain that you get a timely response. We at 2B Tech pride ourselves on the excellent customer service we provide.

You may also contact us by email at techsupport@2btech.io or by phone at +1(303)273-0559. In either case, a web ticket will be created, and future communications with you will be through that ticket.

Initial support involves troubleshooting and determination of parts to be shipped from 2B Technologies to the customer in order to return the product to operation within stated specifications. If such support is not efficient and effective, the product may be returned to 2B Technologies for repair or replacement. Prior to returning the product, a Repair Authorization Number (RA) must be obtained from the 2B Technologies Service Department. We will provide you with a simple Repair Authorization Form to fill out to return with the instrument.

Shipping

2B Technologies will pay freight charges for replacement or repaired products shipped to the customer site. Customers shall pay freight charges for all products returning to 2B Technologies.

Conditions

The foregoing warranty shall not apply to defects resulting from improper or inadequate maintenance, adjustment, calibration or operation by the customer. Maintenance, adjustment, calibration or operation must be performed in accordance with instructions stated in this manual. Usage of maintenance materials purchased from suppliers other than 2B Technologies will void this warranty.

Limitation of Remedies and Liability

The remedies provided herein are the Customer's sole and exclusive remedies. In no event shall 2B Technologies be liable for direct, indirect, special, incidental or consequential damages (including loss of profits) whether based on contract, tort or any other legal theory. The Ozone Monitor manual is believed to be accurate at the time of publication and no responsibility is taken for any errors that may be present. In no event shall 2B Technologies be liable for incidental or consequential damages in connection with or arising from the use of the Ozone Monitor manual and its accompanying related materials. Warranty is valid only for the country designated on the 2B Technologies quote or invoice.

WARNINGS

ENGLISH

**WARNING:**

Any operation requiring access to the inside of the equipment, could result in injury. To avoid potentially dangerous shock, disconnect from power supply before opening the equipment.

WARNING:

This symbol, , on the instrument indicates that the user should refer to the manual for operating instructions.

WARNING:

If this instrument is used in a manner not specified by 2B Technologies, USA, the protection provided by the instrument may be impaired.

ESPAÑOL

**ATENCIÓN:**

Cualquier operación que requiera acceso al interior del equipo, puede causar una lesión. Para evitar peligros potenciales, desconectarlo de la alimentación a red antes de abrir el equipo.

ATENCIÓN:

Este símbolo, , en el instrumento indica que el usuario debería referirse al manual para instrucciones de funcionamiento.

ATENCIÓN:

Si este instrumento se usa de una forma no especificada por 2B Technologies, USA, puede desactivarse la protección suministrada por el instrumento.

FRANÇAIS

**ATTENTION:**

Chaque opération à l'intérieur de l'appareil, peut causer du préjudice. Afin d'éviter un shock qui pourrait être dangereux, déconnectez l'appareil du réseau avant de l'ouvrir.

ATTENTION:

Le symbole, , indique que l'utilisateur doit consulter le manuel d'instructions.

ATTENTION:

Si l'instrument n'est pas utilisé suivant les instructions de 2B Technologies, USA, les dispositions de sécurité de l'appareil ne sont plus valables.

DEUTSCH

**WARNHINWEIS:**

Vor dem Öffnen des Gerätes Netzstecker ziehen!

WARNHINWEIS:

Dieses, , auf dem Gerät weist darauf hin, daß der Anwender zuerst das entsprechende Kapitel in der Bedienungsanleitung lesen sollte.

WARNHINWEIS:

Wenn das Gerät nicht wie durch die Firma 2B Technologies, USA, vorgeschrieben und im Handbuch beschrieben betrieben wird, können die im Gerät eingebauten Schutzvorrichtungen beeinträchtigt werden.

ITALIANO

**ATTENZIONE:**

Qualsiasi intervento debba essere effettuato sullo strumento può essere potenzialmente pericoloso a causa della corrente elettrica. Il cavo di alimentazione deve essere staccato dallo strumento prima della sua apertura.

ATTENZIONE:

Il simbolo, , sullo strumento avverte l'utilizzatore di consultare il Manuale di Istruzioni alla sezione specifica.

ATTENZIONE:

Se questo strumento viene utilizzato in maniera non conforme alle specifiche di 2B Technologies, USA, le protezioni di cui esso è dotato potrebbero essere alterate.

DUTCH

**OPGELET:**

Iedere handeling binnenin het toestel kan beschadiging veroorzaken. Om iedere mogelijk gevaarlijke shock te vermijden moet de aansluiting met het net verbroken worden, vóór het openen van het toestel.

OPGELET:

Het symbool, , geeft aan dat de gebruiker de instructies in de handleiding moet raadplegen.

OPGELET:

Indien het toestel niet gebruikt wordt volgens de richtlijnen van 2B Technologies, USA gelden de veiligheidsvoorzieningen niet meer.

CHINESE

**警告：**

任何需要接触设备内部的操作均可能造成人身伤害。为避免可能的触电危险，请在打开设备前切断电源。

警告：

这个符号 , 在仪器上表示用户应参考说明书上的操作指南。

警告：

如果仪器没有按照美国2B科技公司指定方式操作，仪器的保护性能会减弱。

JAPANESE

**警告：**

機器の内部で操作する時、怪我できます。危険な衝撃を回避するために、機器を開ける前に、電源を切断してください。

警告：

機器でこの記号 , を見れば、マニュアルを読んでください。

警告：

この機器は2Bテクノロジー会社、USAの指定でなければ、機器の保護が損なえます。

1. OZONE MONITOR INTRODUCTION

The 2B Technologies Model 106-M Ozone Monitor is designed to enable accurate measurements of ozone in air over a wide dynamic range extending from 10 parts-per-billion by volume (ppb) to an upper limit of 1000 parts-per-million (ppm) based on the well-established technique of absorption of ultraviolet light at 254 nm. The Ozone Monitor is light weight (3.9 lb, 1.8 kg) and has a low power consumption (~6.0 watt) relative to conventional instruments and is therefore well suited for applications such as:

- long-term monitoring at remote locations where power is highly limited
- monitoring and control of ozone in industrial settings
- monitoring of exposure to individuals in the workplace
- personal exposure monitoring for studies of health effects of air pollutants

An Industrial enclosure along with multi-channel versions of the Model 106-M Ozone Monitor are available to enable automatic or manual sampling of multiple air streams. See Appendix D for a description, specifications, and operating information about the 3-channel and 6-channel instruments (Model 106-M-MC3, Model 106-M-MC6). The Model OEM-106-M Ozone Monitor, which does not have an enclosure and can be used for Original Equipment Manufacturer (OEM) applications, is also offered (see Figures 7.1b, 7.2b, and 7.3b, and Appendix E).

1.1 Theory of Operation

Absorption of UV light has long been used for measurements of atmospheric ozone with high precision and accuracy. The ozone molecule has an absorption maximum at 254 nm, coincident with the principal emission wavelength of a low-pressure mercury lamp. Fortunately, few molecules found at significant concentrations in the atmosphere absorb at this wavelength. However, interferences, such as organic compounds containing aromatic rings, can occur in highly polluted air.

Figure 1.1 is a schematic diagram of the Ozone Monitor. Ozone is measured based on the attenuation of light passing through a 6-cm absorption cell fitted with quartz windows. A low-pressure mercury lamp is located on one side of the absorption cell, and a photodiode is located on the opposite side of the absorption cell. The photodiode has a built-in interference filter centered on 254 nm, the principal wavelength of light emitted by the mercury lamp. An air pump draws sample air into the instrument at a flow rate of approximately 1 L/min. A solenoid valve switches so as to alternately send this air directly into the absorption cell or through an ozone scrubber and then into the absorption cell. The intensity of light at the photodiode is measured in air that has passed through the ozone measurement scrubber (I_o) and air that has not passed through the scrubber (I). Ozone concentration is calculated from the measurements of I_o and I according to the Beer-Lambert Law:

$$C_{O_3} = \frac{1}{\sigma l} \ln\left(\frac{I_o}{I}\right)$$

where l is the path length (6 cm) and σ is the absorption cross section for ozone at 254 nm ($1.15 \times 10^{-17} \text{ cm}^2 \text{ molecule}^{-1}$ or $308 \text{ atm}^{-1} \text{ cm}^{-1}$), which is known with an accuracy of approximately 1%. The 2B Technologies instrument uses the same absorption cross section (extinction coefficient) as used in other commercial instruments.

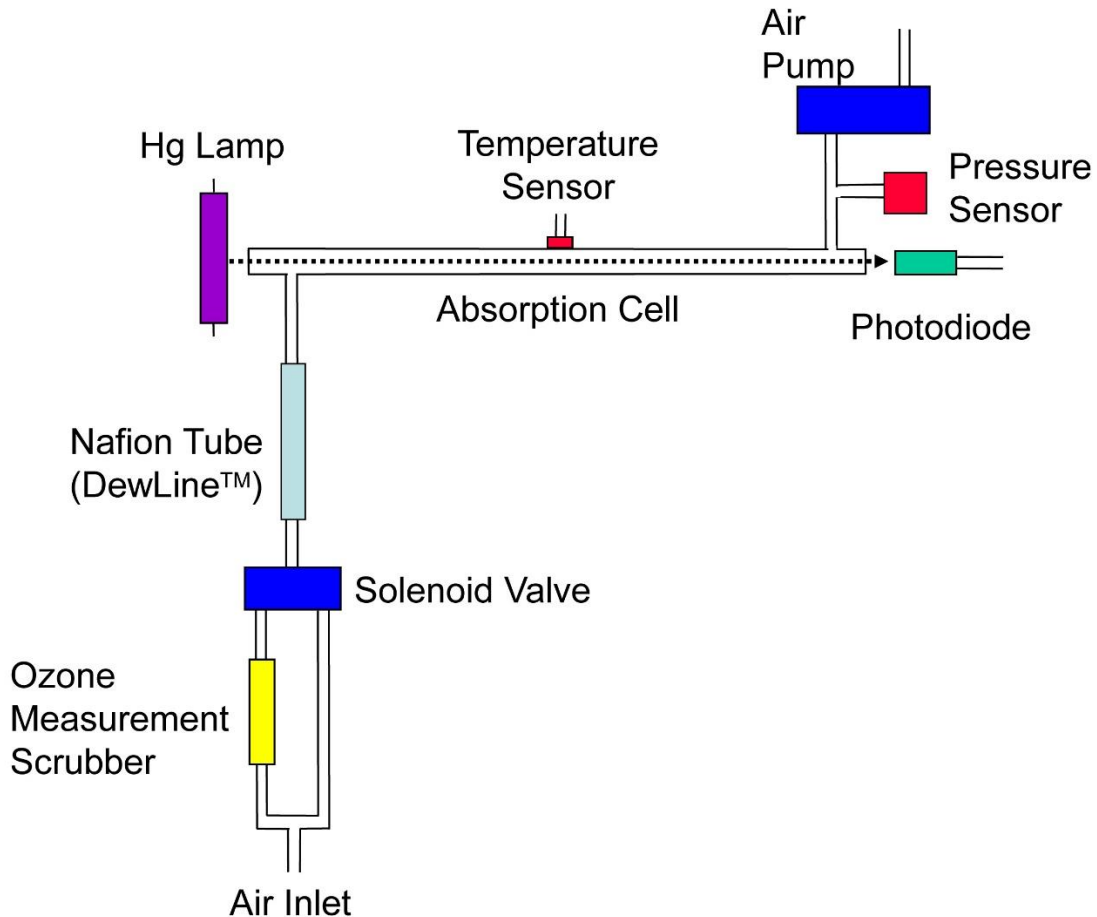
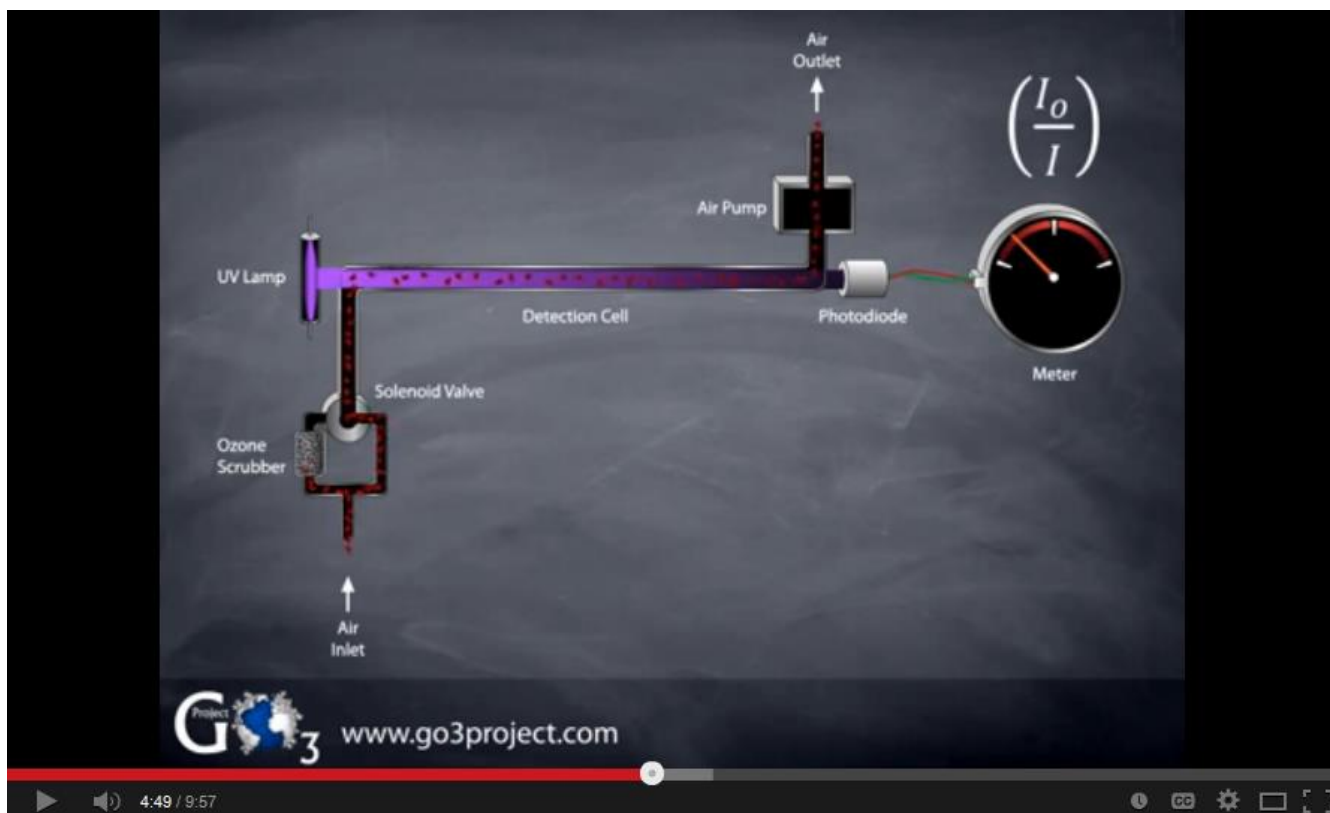

Figure 1.1. Schematic Diagram of the Ozone Monitor.

The pressure and temperature within the absorption cell are measured so that the ozone concentration can be expressed as a mixing ratio in parts-per-million by volume (ppm). The instrument displays and records the cell temperature and pressure in addition to the ozone mixing ratio. The cell pressure is displayed and logged in units of mbar or torr and the cell temperature in units of either °C or K.

The following animated video developed by 2B Technologies provides a detailed explanation of how this and other UV-based ozone monitors measure ozone. Click on the link or image below:



1.2 Calibration Overview

In principle, the measurement of ozone by UV absorption requires no external calibration; it is an absolute method. However, non-linearity of the photodiode response and electronics can result in a small measurement error. Therefore, each instrument is compared with a NIST-traceable standard ozone spectrophotometer in the laboratory over a wide range of ozone mixing ratios. These results are used to calibrate the Ozone Monitor with respect to an offset and slope (gain or sensitivity). The corrections for offset and slope are recorded in the instrument Birth Certificate. These calibration parameters are entered into the microprocessor prior to shipment. The user may change the calibration parameters from the front panel if desired. It is recommended that the instrument be recalibrated at least once every year and preferably more frequently. The offset may drift due to temperature change or chemical contamination of the absorption cell. As discussed in Section 3.10 and Section 6 below, an accurate offset correction can be measured from time to time using the external ozone scrubber supplied with the instrument.

1.3 The DewLine™

Not shown on Figure 1.1 is the DewLine™, which serves to make the humidity entering the detection cell identical during I and I_o measurements. Please see our website for a technical discussion of the DewLine™ and its importance to ozone

measurements: <https://2btech.io/dewline/>. Briefly, water vapor adsorbed to the inner wall of the detection cell changes the reflectivity of the cell. If humidity is not the same during I and I_0 measurements, an offset in the ozone measurement will occur and can be up to several tens of ppb for sudden changes in ambient humidity. The offset will change with time as the internal ozone scrubber equilibrates with water vapor. Even for fixed-site ozone monitors, an offset measurement error will occur if the instrument is zeroed with dry tank air and then used to measure ozone in humid air. The DewLine™ solution to this often-ignored problem is unique to 2B Tech instruments.

1.4 Adaptive Filter

The Model 106-M firmware has the capability to sample the ozone concentration data through a built-in adaptive filter. By default, this filter is turned off. The user can choose to activate this filter, which smooths the data via an averaging algorithm described below. The filter is particularly helpful during periods of high measurement noise or when the ozone concentration is expected to jump to a significantly higher or lower level because of changing ambient conditions.

During operation of the adaptive filter, the firmware will automatically switch between two different filter lengths based on the conditions at hand, as determined by settings specified by the user. 2B Technologies recommends the following settings for the adaptive filter:

- adaptive filter change difference: 30 (ppb)
- adaptive filter change percent: 5 (%)
- adaptive filter change Long average: 25 (number of points)
- adaptive filter change Short average: 10 (number of points)

During the measurement of stable concentrations, the firmware, with the above settings, computes an average of the last 25 raw two-second measurements, or 50 seconds of measurements. This provides smooth and stable readings by averaging out a considerable amount of random noise to improve the precision. If the filter detects rapid changes in concentration, the filter reduces the averaging to only 10 samples or 20 seconds, to allow the analyzer to respond more quickly. Two conditions must be simultaneously met to switch to the short filter. First, the instantaneous concentration must differ from the average in the long filter by at least 30 ppb. Second, the instantaneous concentration must differ from the average in the long filter by at least 5% of the average in the long filter. The lengths of the long and short filter can be changed as well as the minimum difference and percent difference. This can be done via the serial connection as outlined in the Serial Menu section in this manual (see Section 3.15).

To disable the adaptive filter, set the difference to 0 and the percent to 0 (these are the default settings in the instrument as shipped).

Note, the adaptive filter is not used in the multi-channel configurations, Model 106-M-MC3 and Model 106-M-MC6.

2. SPECIFICATIONS: Model 106-M and OEM-106-M Ozone Monitor

Please see Appendix D for specifications of the multi-channel configurations of the Model 106-M.

Measurement Principle	UV Absorption at 254 nm, single beam
Linear Dynamic Range	0-1000 ppm (1,000,000 ppb)
Resolution	0.01 ppm
Precision (1σ) for 10-s average (rms noise)	Greater of 0.01 ppm or 2% of measurement
Limit of Detection (2σ)	0.02 ppm (20 ppb) for 10-s averaging
Accuracy	Greater of 0.01 ppm or 2% of measurement
Baseline Drift	< 0.01 ppm/day; < 0.03 ppm/year
Sensitivity Drift	< 1%/day; < 3%/year
Calibration	NIST Traceable, Annual Calibration Recommended
Measurement Time and Frequency	2 s, 0.5 Hz
Data Averaging Options	10 s, 1 min, 5 min, 1 hr
Response Time, 100% of Step Change	For 2-s output: 4 s, 2 data points For 10-s output: 20 s, 2 data points
Adaptive Filter	Available; user-defined parameters
Data Logger Capacity	32,736 lines (2-s meas. = 0.7 days; 10-s avg. = 3.8 days; 1-min avg. = 22.7 days; 5-min avg. = 113 days; 1-hr avg. = 3.7 yr)
Data Transfer Baud Rates	2400, 4800, 19200
Ozone Units	ppb, pphm, ppm, $\mu\text{g m}^{-3}$, mg m^{-3}
Temperature Units	$^{\circ}\text{C}$, K
Pressure Units	mbar, torr
Temperature and Pressure Corrected	Yes
DewLine™ for Humidity Control	Yes
Operating Temperature Range	0 to 50 $^{\circ}\text{C}$
Flow Rate	Minimum required: 0.3 L/min; Nominal: 1 L/min; Maximum: 1.5 L/min
Power Requirements	100-240 VAC, 50/60 Hz 11-28 VDC, nominally 500 mA at 12 V, 6 watt
Digital Data Outputs	USB, RS232, LCD display
Analog Data Outputs	0-2.5 V, 4-20 mA, user-scalable in menu

Relays with 2 Set Points	Two available: Relay 1 responds based on user's ozone set points. Relay 2 responds based on user's ozone set points OR responds based on diagnostics (T, P, flow, lamp voltage) Four relays provided in Industrial model and in the multi-channel optional configurations
Power Requirements	100-240 VAC, 50/60 Hz 11-28 VDC, nominally 500 mA at 12 V, 6 watt
Bluetooth	Optional
Multi-Channel Configuration	Optional; 3-channel or 6-channel configurations (see Appendix D)
Flow-Through Configuration	Optional
Size	Standard: 3.6 × 7.9 × 9.4 in (9 × 20 × 24 cm) OEM: 2.5 × 7 × 9 in (6.4 × 17.8 × 22.9 cm) Industrial: 16 × 14 × 9.3 in (40.7 × 35.7 × 23.6 cm)
Weight	Standard: 3.9 lb (1.8 kg) OEM: 2.5 lb (1.1 kg) Industrial: ~14 lb (6.4 kg)
Options	Battery, Particle Filter, Bluetooth, Exhaust Port, Flow-Through Configuration, Multi-Channel Configuration, Corrosion Resistance

3. OPERATION

Please read all the following information before attempting to install the Ozone Monitor. For assistance, please call 2B Technologies at (303)273-0559.

NOTE:
Save the shipping carton and packing materials that came with the Ozone Monitor. If the Ozone Monitor must be returned to the factory, pack it in the original carton. Any repairs as a result of damage incurred during shipping will be charged.

3.1 Shipping Box Contents

Open the shipping box and verify that it contains all of the items on the shipping list. If anything is missing or obviously damaged, contact 2B Technologies immediately.

3.2 Operation of the Ozone Monitor

3.2.1 Overview

To operate the Ozone Monitor, connect it to an external power source and power the instrument by switching the power switch on. The instrument requires a 12 V DC source which can be supplied by: 1) the 100-240 V AC power adapter, 2) a cigarette lighter adapter plugged into a 12 V DC source such as found in an automobile or

many light aircraft, or 3) a 12 V battery. The source can be in the range 11-28 V DC without any detrimental effects on the measurement. When using a battery, be certain to attach the positive (red) and negative (black) wires correctly. Batteries and battery chargers are available from 2B Technologies. A circuit breaker and diode are installed on the circuit board in case of an electrical short or incorrect battery attachment. If activated, the breaker will reset itself after a few minutes.

Lead-acid batteries are available from numerous manufacturers in a wide range of sizes and amp-hour ratings. The larger of these, such as those for automobiles or boats, will supply power for up to several weeks. Battery packs in the correct voltage range may be constructed from nickel-cadmium (rechargeable) or lithium (light weight but not rechargeable) batteries for operation for a few hours. Battery options available through 2B Technologies may be found on our webpage: [Model 106-M](#)

Once turned on, the instrument will display the version number of the software installed on the microprocessor and the instrument serial number. After a few seconds, the instrument will start displaying readings for ozone. The first dozen readings (requiring about two minutes) will be spurious, with large positive and negative swings due to the rapid warmup of the lamp and electronics. Also, ozone readings may be inaccurate during the 10-20 minutes required for the lamp, photodiode, and internal temperature of the absorption cell to stabilize.

Inlet tubing may be attached to the ¼ inch nylon Swagelok fitting on the back of the instrument. The inlet tubing should be made of PTFE (Teflon[®]), PFA, FEP, PVDF, or some other inert material that does not destroy ozone and that does not desorb plasticizers and other organics that can contaminate the flow path. The length of tubing should be kept as short as possible (preferably not more than a few feet) to minimize ozone destruction within the inlet tubing. Tygon[®], polypropylene (which may look like Teflon) and metal tubing should not be used. FEP-lined Tygon tubing, which is used inside the instrument provides the flexibility of Tygon with the inertness of FEP. A Teflon or PVDF inlet filter is highly recommended to prevent internal contamination of the tubing and absorption cell by particulate matter. The filter should be tested for ozone loss by measuring ambient ozone with and without the filter attached. Filters and filter holders are available through 2B Technologies. The instrument does not have a plumbed exhaust. After passing through the absorption cell, the sample air is scrubbed and then vented to the inside of the Model 106-M enclosure. **Caution: Do not pressurize the inlet of the instrument. It will damage the instrument. Use a tee to vent at the inlet if you are providing a flow to the instrument.**

Although the instrument compensates for temperature drift, if strong temperature fluctuations are expected, as in vertical profiling applications using balloons, the instrument should be placed in a thermally insulated box.

If using the Model 106-M Ozone Monitor downstream of an ozone generator, it is important to use dry oxygen (not air) as the feed gas for the ozone generator. This will avoid production of corrosives such as nitric acid, which will damage 2B Tech's low-concentration Ozone Monitors (such as Models 106-L and 106-M). Please see our [Tech Note #49](#) on this topic.

3.2.2 Operating Recommendations

The following table gives a summary of the operating recommendations mentioned in this manual.

Operating Recommendation	Frequency	Section Reference
Allow ~20 minutes for instrument warmup before taking data	Each startup	3.2
Inlet tubing should be made of inert materials, such as PTFE, PFA, FED, PVDF (do not use Tygon®, polypropylene, or metal tubing). Minimize length of inlet tubing as much as possible.	Each use	3.2
Use a Teflon or PVDF inlet filter; test it for ozone loss	Each use	3.2
Check the zero offset	Occasionally	3.10, 6
Perform multipoint calibration	<ul style="list-style-type: none"> • Annually • Any time major disassembly of components is performed • Any time the zero or span checks give results outside of the acceptable limits 	5
If strong temperature fluctuations are expected, place the instrument in a thermally insulated box	User-defined	3.2
Use adaptive filter if rapidly changing ozone concentrations are occurring or are anticipated	User-defined	1.4
If using the Model 106-L or Model 106-M Ozone Monitor downstream of an ozone generator, be sure to use dry oxygen (not air) as the feed gas for the ozone generator to that corrosives will not be produced by the ozone generator.	Each use	3.2
Do not pressurize the inlet of the instrument. Use a tee to vent at the inlet if you are providing a flow to the instrument.	Each use	3.2

3.3 The LCD Menu

Many aspects of the Ozone Monitor's operation may be accessed from the LCD menu. The following diagram summarizes the complete instrument Menu.

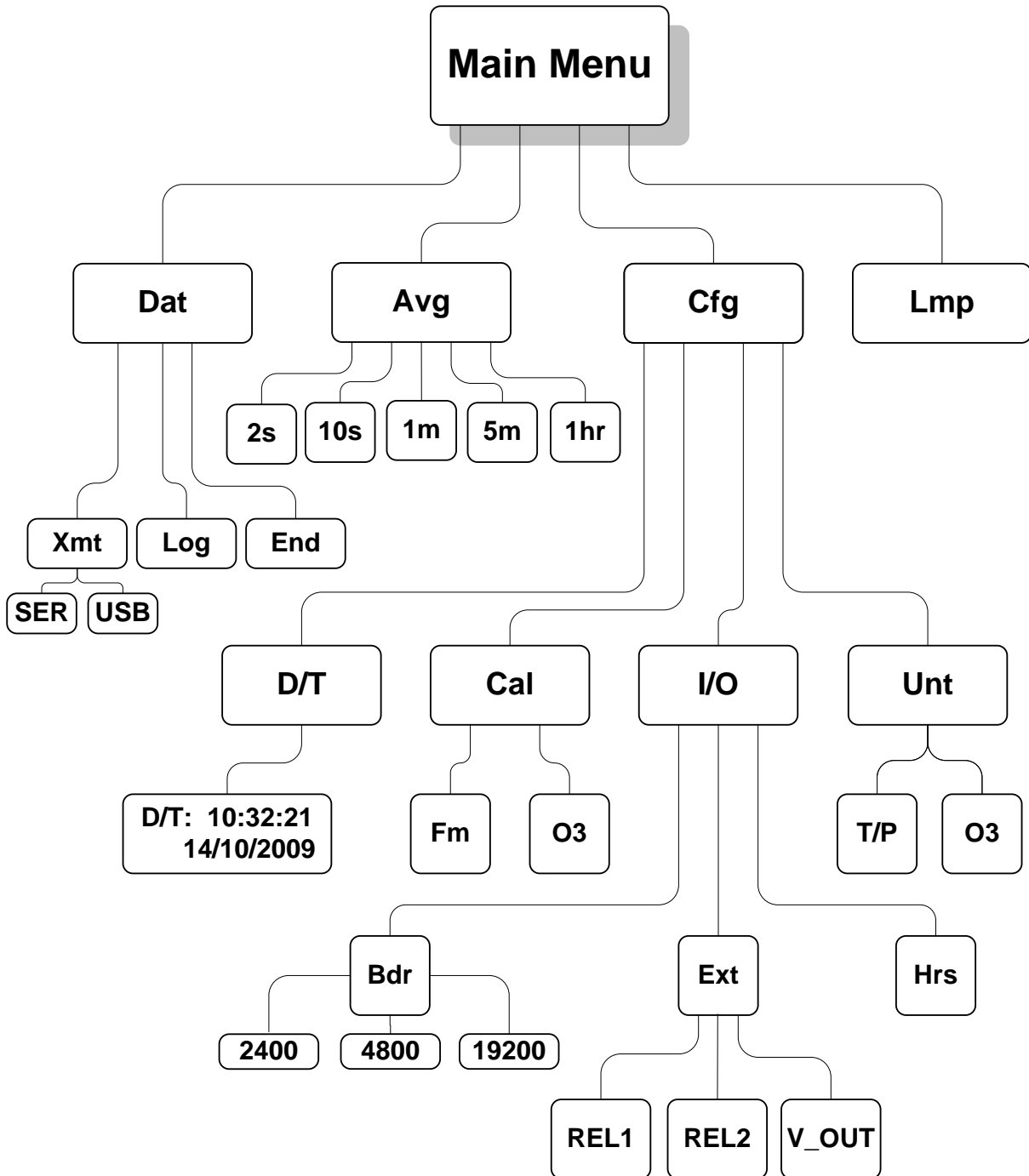

Figure 3.1. Instrument Menu.

3.4 Selecting the Main Menu

When first turned on, the instrument will start making measurements. The Main Menu is accessed using the Select switch on the front panel of the instrument. To reach the Main Menu, press and *hold in* the Select switch until

Menu

is displayed, then release the Select switch. After a few seconds the Main Menu will appear:

Menu
Dat Avg Cfg Lmp ←

where **Dat**, **Avg**, **Cfg** and **Lmp** are submenus that may be selected. A blinking cursor will show across the **D** of the **Dat** submenu. The Select switch may be rotated clockwise or counterclockwise to move the cursor under the first letter of one of the other submenus. To select a particular submenu, move the cursor under the first letter of the submenu and momentarily press (“click”) the Select switch. To exit the Main Menu and begin making measurements again, select and click on the left arrow (←).

3.5 Making Measurements without Averaging or Logging

Select the **Dat** submenu from the **Main Menu** by rotating and then clicking the Select switch. The display will now show:

Dat Menu
Xmt Log End ←

Click on **End** to make measurements without logging new data. This will return you to the **Main Menu**. Select the **Avg** submenu and 2 s to make measurements without averaging. Click on ← to return to the **Main Menu** and click ← again to exit the Main Menu and start making measurements without logging or averaging. Note that “←” always takes you up one level in the menu.

The Ozone Monitor will then alternate every few seconds between displaying the most recent O₃ measurement along with other instrument measurements. For example, the display might read

O3= 63.27 ppm
T=33.3 P=989.7

where the current O₃ measurement is 63.27 ppm (by volume), the temperature is 33.3°C and the pressure is 989.7 mbar (see Section 3.9 below for setting other options for the units used for T, P, and O₃). A few seconds later, this display will be followed by

O3= 62.24 ppm
F=850 V=1.433

showing that the flow rate is 850 cc/min and the photodiode voltage is 1.433 volts.

3.6 Data Averaging and Data Logging Using the Menu

3.6.1 To Average the Data without Logging

Four modes of averaging can be selected by choosing **Avg** from the **Main Menu**. Hold down the Select switch to obtain the **Main Menu**. Select and click on **Avg** to obtain the **Avg** menu:

Avg Menu
2 s 10s 1m 5m 1h ←

Rotate the Select switch to move the cursor to **10s**, **1m**, **5m** or **1h** for averaging. Then click on the averaging time you want to use. You will be returned to the **Main Menu**. To exit the Main Menu and start acquiring data, click on ← again.

When 2s is selected, the rapid raw output of the monitor is viewed every 2 seconds. When 10s is selected, the unit is in the default operating mode. In this mode, the average of five 2-s measurements is displayed and updated. When averaging for 1m, 5m, or 1h is selected, the two displays discussed above in Section 3.5 will alternate with a display such as

Avg O3= 63.15 ppm
19:55 05/02/21

for example, where the most recent average value of ozone computed is 63.15 ppm, the time of the measurement is 7:55 p.m. and the date is 5 February 2021. Averaged data may be logged, thereby greatly extending the length of time that the internal data logger can be used (see next section).

3.6.2 To Log Data

Data may be logged in the internal data logger. Up to 32,736 data lines containing log number, ozone mixing ratio, internal (cell) temperature, internal (cell) pressure, flow rate, photodiode voltage, date and time may be stored in internal memory. Measurement output of 2 s, and averaging options of 10 s, 1 min, 5 min and 1 hr may be selected from the menu (see below), thereby allowing the instrument to operate and log data for 18 hours, 3.8 days, 22.7 days, 113 days and 3.7 years, respectively, before filling the memory.

To begin logging data, select the **Dat** submenu from the Main Menu using the Select switch. The display will now show

Dat Menu
Xmt Log End ←

To start logging data, rotate the Select switch to move the cursor to **Log** and click to select the logging mode. You will then receive the prompt:

Overwrite Data?
No Yes ←

Warning: If you start logging, all data previously stored in the logger will be irretrievably lost. If you have data in the logger that you want to keep, be sure to download it (see Section 3.14 below) before starting logging.

Click on **Yes** if you are sure you want to start logging new data. This will return you to the **Dat** submenu. Click on ← to return to the **Main Menu**, and click on ← again to exit the Main Menu and start making measurements. Note that “←” always takes you up one level in the menu.

When data are being logged, the log number and number of new measurements made for the next average (minus 1) are displayed in place of the data and time; e.g.,

Avg O3= 24.16 ppm
Log= 193:4

where **Avg O3** is the average ozone value most recently written to the logger, and the current log number is 193. The “4” in 193:4 refers to the number of 10-s data points that have been measured so far for inclusion in the next average to be displayed and logged. If 1-min averaging is used, this number will increment from 0 to 5; for 5-min averaging, the number will increment from 0 to 29; and for 1-hr averaging, it will increment from 0 to 359. This number is displayed so that the user will know how many more 10-s measurements need to be made before a new average is displayed and logged.

Note that if the menu is entered when an average is in progress, that average value will be lost and a new average will be started when measurements are resumed.

If there is a power failure while the instrument is in the logging mode, logging will resume after power is restored. A note of “Data Interruption” will be written to the logger prior to writing the first new data line. The instrument can accommodate multiple data interruptions due to power failures. For example, one can purposely switch the instrument off, move to another location and restart logging simply by turning the instrument back on. Data sets will be separated by the data interrupt message.

3.7 To Stop Logging Data

Hold in the Select switch to obtain the **Main Menu**. Go to the **Dat** submenu by clicking on **Dat**. Choose and click on the **End** function. This will end data logging. You may now return to the **Dat** menu to transmit the data to a computer by clicking on **Xmt** (see below). The stored data will reside in memory (even when new measurements are being made) and can be transmitted using the **Xmt** function as often as you like. However, all stored data are lost once logging is started again using the **Log** function. Thus, you should always transmit your data to a computer before restarting logging.

If you fail to **End** logging prior to transmitting the data using **Xmt**, the instrument will automatically execute the **End** function for you prior to transmitting the data.

3.8 To Set the Time and Date

From the **Main Menu**, select the **Cfg** submenu. Next, select the **D/T** submenu. The display will read, for example:

D/T: 14:32:21 ←
17/10/2020

meaning that it is 21 seconds after 2:32 p.m. on October 17, 2020 (military time and European date). To change a number in the date and time, rotate the Select switch to underline the numeral you want to change. A single click then causes a blinking cursor to cover that numeral. The number can then be changed by rotating the Select switch. Once the number is correct, click on the Select switch to turn off the blinking cursor. You may now rotate the Select switch to choose another numeral to change. Once the time and date is correct, clicking on ← will set the internal clock to that time and return the display to the **Cfg** menu. As in setting a digital watch, the seconds should be set in advance of the real time since the clock starts to run again only when the set time is entered, in this case by clicking on ←.

3.9 To Change the Ozone, Temperature, and Pressure Measurement Units

From the **Cfg** submenu, choose the **Unt** submenu:

Unt Menu
T/P O3 ←

Choose O3 to change the ozone units:

O3 Units Menu
Ozone: ppm ←

Select **ppm**, depress the select switch to obtain a blinking cursor and rotate the select switch to choose between units of ppb, pphm, ppm, $\mu\text{g}/\text{m}^3$ and mg/m^3 . Press the select switch again to remove the blinking cursor, and return to the **Unt** menu using the left arrow. Ozone concentrations will now be calculated and reported in the chosen units.

Select T/P to change the temperature and pressure units:

T/P Units Menu
T:C P:mbar ←

You may now select units of °C or K for temperature and mbar or torr for pressure using the same procedure used to set the units for ozone concentration.

3.10 Measurement of the Zero Offset

The electronic zero of the instrument may be measured by attaching an ozone destruction cartridge to the air inlet for a period of 5-10 minutes. For an accurate measurement, the instrument must have been turned on long enough for the internal temperature to stabilize (normally ~20 minutes). The observed offset, which can amount to \pm a few ppb, can be corrected for by changing the offset calibration parameter (Z) from the front panel, as described in Section 3.11 below.

3.11 To Set the Calibration Parameters

The instrument is calibrated at the factory, where slope (S) and offset (Z) parameters are entered into the instrument's memory. These preset calibration parameters are

given in the instrument's Birth Certificate and recorded on the calibration sticker on the top of the absorption cell inside the instrument. However, the calibration parameters may be changed by the user. For example, it may be desirable to provide a positive offset by a known amount (e.g., 10 ppb) if the analog output is being used for external data logging, because the analog voltage output does not go negative below zero ppb, and the current output does not go below 4 mA. Because of noise and/or an inherent offset, some measured values will be below zero at very low ozone mixing ratios or while zeroing the instrument with an external scrubber. Also, the instrument zero may drift by a few ppb over time. For this reason, frequent zeroing of the instrument using an external ozone scrubber to determine the offset is recommended. Any change in the slope (gain) of the instrument is likely due to a serious problem such as contamination, an air leak, obstruction of air flow, or loss of catalytic activity by the internal ozone scrubber, but it also can be adjusted. Once the zero of the instrument is corrected, the slope may be adjusted so that the instrument readout agrees with a standard ozone source (such as the 2B Technologies Model 306 Ozone Calibration Source™) or with the readout from another instrument whose calibration is considered to be accurate.

To change the calibration parameters, choose the **Cfg** submenu from the **Main Menu** and click on **Cal** to obtain the display

Cal Menu
Fm O3 ←

Click on the **Fm** submenu to display the calibration factor for the internal flow meter.

Fm Cal Menu
Fm= 0.92 ←

This is a multiplicative factor that will increase the flow rate if you increase the value. Adjust this value to correct the measured flow rate when comparing it to a calibrated volumetric flow meter connected to the inlet of the instrument.

Click on the **O3** calibration submenu to obtain, for example

O3 Cal Menu
Z= -6 S= 1.01

Here Z is the offset applied in units of ppb (in this case -6 ppb) and S is the slope applied (in this case 1.01). The value of Z is added to the measured ozone value, and the value of S is then multiplied by the measured ozone value. During calibration, Z is set to 0 and S set to 1.00; if the instrument reads an average of 6 ppb with the external scrubber in place, the value of Z should be set to -6. If after correction for the zero, the instrument consistently reads 2% low, the value of S should be set to 1.02.

When the **Cal Menu** first appears, the **Z** will be underlined with a cursor. You may rotate the Select switch to choose the calibration parameter **S** or **Z**. A single click on **S** or **Z** will select that parameter for change and activate a blinking cursor. Once **S** or **Z** is selected, its value can be changed by rotating the Select switch to the left or right. After choosing the desired value, a click turns off the blinking cursor and allows you to scroll to the other parameter or to ← to exit the submenu. Once the values of **Z** and **S** are set, clicking on ← will return the display to the **Cfg** menu, and another click on ←

will return to the **Main Menu**. The calibration parameters reside in non-volatile memory and are not affected by power failures.

In order to adjust the zero offset, after the instrument has warmed up for at least 20 minutes attach the external ozone scrubber and make measurements for a few minutes. If the average of those measurements is 4.4 ppb, for example, subtract 4 from the current value of Z; i.e., if Z was set to 3 during the measurements, change Z to -1. For more details about calibrating the ozone monitor against another instrument or calibrated ozone source, see the “Calibration” section (Section 5) of this manual or refer to [Tech Note No. 15](#).

3.12 Collecting Data over the USB or Serial Port in Real Time

To transmit data to a computer over the USB or serial port in real time, connect the Ozone Monitor to the USB or serial port of the computer. Plug the cable in after powering the Ozone Monitor Model 106-M to ensure correct functionality.

For the serial port connection, use the 9-pin cable provided. Note that this is a “straight-through” female-female serial cable. A “cross-over” cable will not work. The RS232 protocol is 2400, 4800 or 19200 baud as selected in the menu; 8 bits; no parity; 1 stop bit. The digital pinout for the RS232 is standard and as follows: Pin 2 = transmit, Pin 3 = receive, Pin 5 = ground. Looking at the back of the instrument, the pin numbers for the connector are:

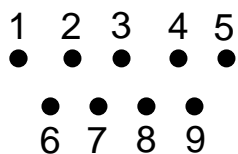

For connection to the USB port of the computer, use either (1) the serial port of the Ozone Monitor and a serial-to-USB cable, or (2) the USB port of the Ozone Monitor and a direct USB-A-Type to-USB-B-Type cable. If using the latter option, the USB driver will automatically enable data acquisition for newer versions of the Model 106 instruments (i.e., having two relays rather than one, serial no. ≥1004M) and computers running newer versions of Windows. If using earlier versions of the Model 106 and/or earlier versions of Windows, download the USB driver (<https://2btech.io/downloads/>, select “Software”) and follow the installation instructions that were in the manual that was included with your instrument (reproduced and updated in this manual as Appendix C).

3.12.1 Data Acquisition Software

Start your data acquisition software, preferably using the [2B Technologies Display and Graphing Software](#). See Appendix A for a summary of working with this software. Other terminal emulation software such as HyperTerminal (a program provided with earlier versions of Windows) or [Tera Term](#) may be used as well.

3.12.2 Determine the Connection Port and Baud Rate Settings

When setting up your software or terminal emulator, choose the correct COM port listed in the Device Manager. If using Windows, go to the control panel and select System and Security > System > Device Manager. Select "Ports" to see the assigned serial or USB COM port number.

For the serial port, the baud rate setting in the data acquisition software must match the baud rate setting of the Model 106-M (2400, 4800, or 19200). Adjust the setting in the software's setup menu and/or in the Model 106-M's Cfg menu, following instructions in Section 3.13 below.

For the USB port, the baud rate setting in the data acquisition software must match the setting that the Model 106-M had at startup. If you wish to change the baud rate of the Model 106, change it in both the instrument and the software, and then reboot the instrument to begin taking data.

3.12.3 Data Output

The ozone mixing ratio, internal cell temperature, cell pressure, time and date are sent as comma-delimited ASCII text to the serial and USB ports every 2 seconds, 10 seconds, 1 minute, 5 minutes, or 1 hour, depending on the averaging time selected from the microprocessor menu. Time is provided in 24-hour (military) format, and the date is given in European style (day/month/year). The user should separately make note of the instrument settings for units (ozone, temperature, pressure), baud rate and averaging time.

A typical data line would read:

4.03,309.4,759.3,840,1.212,15/10/2020,18:31:27

where:

Ozone = 4.03 ppm

Cell temperature = 309.4 K

Cell pressure = 759.3 torr (1 atm = 760 torr)

Flow rate = 840 cc/min (volumetric)

Photodiode Voltage = 1.212 volts

Date = October 15, 2020

Time = 6:31:27 pm

If outputting logged data, the output serial data line will be preceded by the log number; e.g.,

2893,4.03,309.4,759.3,840,1.212,15/10/2020,18:31:27

where 2893 is the log number.

In addition to data lines, messages are written to the USB or serial port when logging is begun or ended, when transmission of data from the logger is begun and ended, when data collection is interrupted (e.g., due to a power failure), and when the averaging time is changed.

See Section 3.15 below for how to access the serial menu and USB menu.

3.13 To Change the Baud Rate

The baud rate for transmission of data to a computer over the USB or serial port may be changed by going to **Menu / Cfg / I/O / Bdr** to obtain:

Baud Menu
2400 4800 19200 ←

Choosing a baud rate will automatically return you to the **I/O** submenu.

3.14 To Transmit Logged Data to a Computer Using the USB or Serial Port

Connect the USB or serial port of the instrument to your computer using the appropriate cable. Enable a data acquisition program on the computer such as the 2B Technologies Display and Graphing Software, which can be downloaded at:

https://2btech.io/downloads/?filter=true&docs_category=docs_software

Appendix A gives a summary of working with this display software. Alternatively, HyperTerminal can be used (provided with early versions of Windows® platforms, usually in Start/All Programs/Accessories/Communications/HyperTerminal) or Tera Term, which can be downloaded at:

<https://2btech.io/wp-content/uploads/teraterm-4.105.zip>

The correct settings for receiving data are: chosen baud rate (2400, 4800, or 19200; see Section 3.12.2); 8 bits; no parity; 1 stop bit.

Click the Select switch to obtain the **Main Menu**. Go to the **Dat** submenu by clicking on **Dat**. Next, click on **Xmt**. The message “Logged Data” will be written to the USB or serial port, followed by a carriage return and all of the lines of logged data. After all data are transmitted, the message “End of Logged Data” and a carriage return are written. After transmission is complete, you can return to any position in the menu or resume ozone measurements. The logged data continues to be available for transmission until a new data log is started. Note that previously logged data are overwritten if logging is restarted.

3.15 Accessing the Serial Menu and the USB Menu

Measurements and logging tasks can be accessed via the serial port or the USB port using a terminal emulator such as Tera Term or HyperTerminal running on an attached computer or the 2B Technologies Display and Graphing software (see links in Section 3.14 above). Commands can be sent using the terminal emulator set with the properties listed in the section of this manual entitled “Collecting Data over the USB or Serial Port in Real Time” (Section 3.12). Listed below are the lower-case letters that are commands for performing certain operations while the instrument continues to measure:

- l** Start logging and write over existing logged data
- t** Transmit logged data
- e** End logging

- h** Output serial data line header
- m** Serial menu

If the letter **m** is sent as a command, **menu>** will be displayed in the terminal emulator window. When the serial or USB menu is accessed, the instrument is no longer making measurements; it is waiting for the next command to be entered. The following is the list of serial or USB menu commands accessible from this point:

Menu Commands: Serial Port and USB Port

- l** Start logging and write over existing logged data.
- t** Transmit logged data.
- e** End logging.
- h** Output serial data line header.
- a** Averaging time: enter a number followed by carriage return (0 = 2 second, 1 = 10 second, 2 = 1 minute, 3 = 5 minute, 4 = 1 hour)
- z** Zero (offset) calibration setting: displays current setting and waits for a setting followed by a carriage return (enter a setting in units of ppb [integers only])
- s** Slope calibration setting: displays current setting and waits for a setting followed by a carriage return (enter a setting and carriage return)
- c** Clock menu: displays current date and time and waits for an entry:
 - n** To exit without changing date or time
 - d** Asks to enter date in DDMMYY format
 - t** Asks to enter time in HHMMSS format
- Y** Set all configuration to default¹.
- b** Adaptive filter difference (integers only; see Section 1.4).
- i** Adaptive filter percent (integers only; see Section 1.4).
- k** Adaptive filter long average length (integers only; see Section 1.4).
- m** Adaptive filter short average length (integers only; see Section 1.4).
- n** Output instrument serial number.
- p** Perform Lamp test (carriage return to end test).
- o** Change relay 2 operation for diagnostics:
 - 1** Enable temperature inclusion for relay 2.
 - !** Disable temperature inclusion for relay 2.
 - 2** Enable pressure inclusion for relay 2.
 - @** Disable pressure inclusion for relay 2.
 - 3** Enable flow inclusion for relay 2.
 - #** Disable flow inclusion for relay 2.
 - 4** Enable pdv inclusion for relay 2.
 - \$** Disable pdv inclusion for relay 2.
- q** Change relay 2 operation for Ozone.
- L** Set to flat temperature sensor (*do not adjust; this is a factory setting*)
- T** Set to round temperature sensor (*do not adjust; this is a factory setting*)
- ?** Output this help menu.
- x** Exit menu and return to measuring.

¹ Default settings: Avg=10 s, offset=0, slope=1, adaptive filter difference=0, adaptive filter percent=0, adaptive filter long average length=25, adaptive filter short average length=10, T in °C, P in mbar, O₃ in ppm, serial number resets to 1000. To reset to original serial number, use command r and password bould.

3.16 Collecting Data from the Analog Output

The data may be logged in real time using a data logger attached to the D9 connector on the back panel of the instrument using either a voltage or current recorder or data logger. The 0-2.5 V voltage output is measured across pins #1 (+) and #5 (ground). The 4-20 mA current output is measured across pins #9 (+) and #5 (ground). Looking at the back of the instrument, the pin numbers for the connector are:

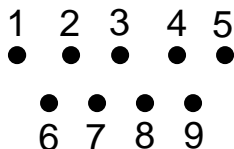

To change the analog output voltage scaling factor, go to **Menu / Cfg / I/O / Ext / VOUT**. If ppm are the selected units, for example, the display will briefly read “VOUT Menu” followed by

2.5V=00100 ppm
20mA=00100 ppm ←

In this example, the output scaling factor is set as 2.5 volt (full scale) = 100 ppm; i.e., 1 volt = 40 ppm. Also, the current output will be scaled such that the full scale of 20 mA corresponds to 100 ppm. A reading of zero ozone concentration will be output as 0 V and as 4 mA. You can use the Select switch to change the scaling factor to the value of your choice by selecting (press in) and changing (by scrolling) the individual digits in the scaling factor of either the voltage or current. Thus, the instrument is not limited to a fixed number of “ranges” common to most ozone monitors. Instead, any range can be defined.

3.17 To Read the Number of Hours of Ozone Monitor Use

The instrument keeps track of the total number of hours of use. This is helpful for determining when the instrument should be serviced, a pump replaced, etc. To read the number of hours of operation choose **Menu / Cfg / I/O / Hrs**.

3.18 Using and Setting the Relay Limits

The Ozone Monitor may be used to control other devices, such as ozone generators, using two 12-amp relays located on the back of the instrument. **REL1** (the bottom relay) may be used for ozone set points, for example to set limits for high levels of ozone. **REL2** (the top relay) may be used for a second set of ozone set points (for example, in the low ozone range), or instead could be used for diagnostics such as temperature, pressure, flow rate, or lamp voltage.

To set the On and Off limits of a relay, choose **REL1** or **REL2** from the **Cfg / I/O / Ext** submenu. The menu will show, for example:

On =0009.90 ppm
Off=0010.10 ←

With these settings, the relay will close (pass current) until the ozone concentration exceeds 10.10 ppm. Above this concentration, the switch relay will open. The relay will not close again until the ozone concentration drops below 9.90 ppm. In this way, for example, the ozone concentration from an ozone generator could be controlled in the range 9.90 to 10.10 ppm. You may now move the cursor using the Select switch to choose the digits in the On and Off relay settings: choose a digit to change by depressing the Select switch, and rotate the Select switch to change those settings. To choose another digit to change, depress the Select switch again to remove the blinking cursor.

Physical connection to the relay is made by means of a supplied screw connector for attaching wires to your device. The center terminal is common. When viewing the connector from the rear of the instrument, the terminal on the right is in normally open (i.e., it closes when the ozone concentration is below the first set point). This is the connection you would ordinarily use. The screw connector on the left is normally closed; i.e., it behaves in the opposite manner as the right screw terminal.

Relay operation is also described in our Technical Note 045, available on our website (https://2btech.io/wp-content/uploads/docs/tech_notes/TN045.pdf).

3.19 Lamp Test

If the instrument is excessively noisy (standard deviation greater than 2 ppb) or always reads near zero even in the presence of ozone, it is useful to perform the lamp test to make sure that the lamp is turning on and does not fluctuate too rapidly. Before performing the lamp test, allow the instrument to warm up for at least twenty minutes.

Choose **Lmp** from the **Main Menu**. The pump will go off and the display will momentarily read "**Lamp Test**". The photodiode voltage will then be displayed, and after a few lamp measurements have been made, the electronic offset and then a little later the standard deviation also will be displayed as, for example:

PDV= 0.89801 V
1.2+/-4.85 ←

The photodiode voltage (PDV) is a measure of the lamp intensity and should be in the range 0.6-2.2 volts. Since absorbance is a ratio measurement, the absolute value of the voltage is not particularly important. However, above 2.5 volts, which could occur if the instrument is allowed to become too hot, the photodiode is saturated and the calculated ozone concentration will be zero. A photodiode voltage less than 0.6 volts is indicative of either a weak lamp or a dirty detection cell and may result in a noisy measurement. The photodiode voltage will typically increase as the instrument warms up. Lamp drift is continuously monitored and corrected for in the firmware and thus has very little effect on the measured ozone concentration. Once the instrument is warmed up, fluctuations in photodiode voltage should be limited primarily to the last digit displayed. The lamp test also calculates an electronic offset and standard deviation of the measurement itself, displayed in the above example as 1.2 ppb for the electronic offset and +/-4.85 ppb for the standard deviation. The standard deviation is

a quantitative measure of the lamp and associated electronic noise. Electronic offsets should normally be -10 to 10 ppb equivalent. After running the lamp test for a few minutes, values above 5.00 for the standard deviation usually indicate an excessively noisy lamp. Lamps seldom “burn out” but may become noisy with time and need to be replaced. Some lamps become noisy after only a short period, while others will be extremely stable for years. If your lamp fails the lamp test during the first year of operation, contact us for a new lamp under the instrument warranty. Contamination of the detection cell may also cause a high standard deviation, in which case the flow path should be cleaned with methanol and the internal ozone measurement scrubber replaced. Please see Appendix B for detailed procedures if you want to perform these operations on site.

3.20 LED Indicator Lights

Four indicator lights are on the left side of the front instrument panel:

- The bottom light is a power indicator. It is always on during normal operation.
- The Low Lamp indicator comes on if the lamp voltage drops below 0.6 volts, indicating that a lamp test should be conducted (Section 3.19) and that the lamp may need replacement and/or the flow path may need cleaning.
- The Low Flow indicator comes on if the flow rate is less than 0.4 L/min. This indicates that there could be leaks, or that the air pump needs replacing. See the Maintenance/Troubleshooting Section of this manual (Section 4).
- The top light indicates the ozone level is above 100 ppb. If the Monitor is sampling ambient air, personnel in the vicinity should take precautions to avoid breathing unsafe levels of ozone.

4. MAINTENANCE/TROUBLESHOOTING

4.1 Overview

The Ozone Monitor is designed to be nearly maintenance-free. The only component that requires routine maintenance is the ozone measurement scrubber (see Figure 1.1 in Section 1), which should be changed at least annually, or after every six months of operation (~4000 hours) of continuous operation. Also, the inlet filter (user supplied) should be changed as recommended by the filter manufacturer.

There are two internal ozone scrubbers (see Figure 7.1 of Section 7). One, the ozone exhaust scrubber (under the LCD display in the photo), is used to scrub ozone before the pump to protect the pump from high ozone damage; the other is for the ozone measurement. The ozone exhaust scrubber does not need to be replaced unless it is visibly leaking material into the pump. The ozone measurement scrubber is connected to the inlet and the “long end” of the solenoid valve. This ozone measurement scrubber should be replaced every six months (~4,000 hours) of continuous operation; otherwise, annual replacement is recommended. To change the internal ozone scrubbers/filters, remove the top cover by removing the six screws that hold it in place. The scrubber can easily be replaced by disconnecting the tubing attached to each end and connecting a new one in its place.

Other components with a limited lifetime are the air pump (~15,000 hours), lamp (~20,000 hours) and solenoid valve (rarely fails). It is recommended that the instrument be returned to 2B Technologies if any of these components fail. Alternatively, the user may install these components at their own risk. In that case, please contact 2B Technologies for instructions.

The following are indications of various instrument malfunctions.

Air Pump Failure: The instrument will not make a humming sound. Also, the circuit breaker may prevent the instrument from powering up if the motor in the air pump develops a short. The Low Flow indicator light (instrument front panel) will activate if the flow falls below 0.4 L/min.

Lamp Failure: The ozone measurements will be erratic and the Lamp Test will show 0.0 volts for the photodiode voltage. The Low Lamp indicator light (instrument front panel) will activate if the lamp voltage falls below 0.6 V.

Solenoid Valve Failure: The ozone readings will be low and average to close to zero if the solenoid valve is not switching. Partial switching of the solenoid valve will cause the instrument to read low but not zero.

Contaminated Flow Path: The instrument will typically have a large positive or negative offset and the ozone readings will be low once corrected for the measured offset.

4.2 Maintenance Recommendations

The following is a summary of recommended maintenance procedures mentioned in this manual.

Maintenance Recommendation	Frequency	Section Reference
Recalibrate instrument and clean flow path	At least once per year	1.2, 3.11, 5.1-5.5, Appendix B
Replace ozone measurement scrubber	every 6 months of continuous operation (~4,000 hrs); otherwise annually	4.1
Clean flow path (methanol)	As needed if instrument has large offset and ozone readings are low, or if readings are noisy	4.1; send instrument to 2B Tech (4.3), or follow cleaning procedures described in Appendix B

4.3 Troubleshooting

Help with troubleshooting is provided in the following table. Refer to Figures in Section 7.

Table I. *Troubleshooting the Ozone Monitor for performance problems.*

Problem/Symptom	Likely Cause	Corrective Action
<i>Instrument does not turn on.</i>	Power not connected properly or circuit breaker open.	Check external power connection for reverse polarity or a short and wait a few minutes for the thermal circuit breaker to reset.
<i>Instrument turns on then powers off.</i>	Burned out air pump.	Remove top cover and unplug air pump. Turn instrument on; if it remains running, then the air pump motor is burned out and shorting. Replace air pump.
<i>Display is blank or nonsense.</i>	Bad connection of display to circuit board.	Remove top cover and reconnect display's ribbon connector to circuit board. Check solder connections to display. A new LCD may be required.
<i>Cell temperature reads low by several 10's of degrees.</i>	Absent or loose connection of temperature probe cable to circuit board.	Remove top cover and reattach connector to circuit board.
<i>Readings are noisy with standard deviations greater than 5 ppb.</i>	Lamp output is weak, below 0.6 V on Lamp Test.	Remove top cover and check lamp connection to circuit board. Run Lamp Test from menu. If photodiode voltage is less than 0.6 V, replace lamp.

Problem/Symptom	Likely Cause	Corrective Action
	Flow path contaminated.	Clean flow path with methanol (send instrument to 2B Tech, or follow Cleaning Procedure described in Appendix B).
<i>Analog output is constant or does not track front display.</i>	Cable not properly connected between analog output and recording device. Wrong scaling factor selected In menu.	Check continuity of your analog cable to your recording device and make sure correct connector pins are being used (see Section 3.16). Check and reset analog output scaling factor in the Menu.
<i>Select switch does not work.</i>	Bad solder joint to circuit board or damaged select switch.	Remove top cover and check solder connection to select switch. It may be necessary to replace the select switch.
<i>Serial port does not work.</i>	Wrong serial cable used. Wrong baud rate selected.	A "straight through" serial cable is provided. Some data collection devices require a "cross over" cable in which pins 1 and 3 are exchanged between the two ends of the cable. Use a "cross over cable or additional connector that switches pins 1 and 3. Make sure that the baud rate chosen in the menu matches the baud rate setting of your data acquisition program.
<i>Required calibration parameters are large (>±9 ppb offset and/or >±9% slope) when calibrated using a standard ozone source or reliable ozone instrument.</i>	Ozone measurement scrubber is contaminated. Flow path is contaminated. Solenoid valve is contaminated and not opening and closing properly	Replace ozone measurement scrubber. Be sure to use an inlet filter to remove particulate matter. Clean flow path with methanol following the Cleaning Procedure (Appendix B) or send instrument to 2B Tech. Remove top cover, unplug pump, turn instrument on and test listen for clicking of solenoid valve every 2 seconds. If solenoid valve is clicking, remove tubing connections and test solenoid valve to confirm that air always flows through common and alternately through normally open and normally closed states.

Problem/Symptom	Likely Cause	Corrective Action
	Air pump is not drawing sufficient flow.	Replace solenoid valve if not working properly (requires soldering). As a first check, hold your finger over the air inlet to determine whether air is being drawn in. If there is flow, measure the flow rate by attaching a high conductance flow meter to the air inlet. Air flow should be greater than 0.6 L/min. If flow is lower, check for leaks. If there are no leaks, replace air pump.
<i>Low Flow indicator light is on (front of monitor)</i>	Flow has fallen below 0.4 L/min.	Check for leaks in your sampling system. If none found, check air pump as noted directly above.
<i>Low Lamp indicator light is on (front of monitor)</i>	Lamp voltage has fallen below 0.6 V.	Remove top cover and check lamp connection to circuit board. Run Lamp Test from menu. If photodiode voltage is noisy and is less than 0.6 V, replace lamp. Also check for contamination of the flow path, and clean with methanol if needed (send instrument to 2B Tech, or follow procedure in Appendix B).
<i>Ozone > 100 ppb indicator light is on (front of monitor)</i>	Measured ozone is above 100 ppb.	If the ozone monitor is sampling ambient air, observe proper health precautions.

2B Technologies offers reasonably priced customer service for instrument repairs. The calibration service includes cleaning of the entire flow path with methanol, testing of all components for proper function, installation of a new internal ozone measurement scrubber and calibration against a NIST-traceable standard. The best way to contact us for service is to log a customer service ticket at <https://2btech.io/support/>. Normally, you will hear back from us by email within a few hours. Or, call us at +1(303)273-0559.

There is a great deal of technical information about our instruments posted as [technical notes](#). These Tech Notes, as well as manuals, brochures, software, cleaning procedures and scientific papers, may be downloaded from the [2B Technologies website](#).

5. CALIBRATION

5.1 Overview

Every analytical instrument is subject to some drift and variation in response, making it necessary to periodically check the calibration. Dynamic calibration is a multipoint check where gas samples of known concentration are sampled by the instrument in order to determine a calibration relationship. For more information on calibration of ozone monitors refer to the Code of Federal Regulations ([Title 40, Part 50, Appendix D](#)) and the EPA's [Technical Assistance Document for the Calibration of Ambient Ozone Monitors](#).

Calibration is the process of adjusting the gain and offset of the Ozone Monitor against some recognized standard. The reliability of the data collected from any analytical instrument depends on the accuracy of the calibration, which is largely dependent upon its analytical traceability to a reference material or reference instrument calibration. This calibration may be performed by the user with the guidelines provided in this section. Alternatively, the ozone monitor may be returned to 2B Technologies for calibration service. 2B Tech's calibration service includes cleaning of the entire flow path with methanol, testing of all components for proper function, installation of a new internal ozone scrubber and calibration against a NIST-traceable standard. The best way to contact us for service is to log a customer service ticket via our website: <https://2btech.io/support/>. Normally, you will hear back from us by email within a few hours. Or, call us at +1(303)273-0559.

Because of the instability of ozone, the certification of ozone concentrations in a compressed gas cylinder is impossible due to loss of ozone over time. When ozone concentration standards are required, the ozone must be generated and certified on site. The following are based on EPA requirements for calibrations of ozone monitors for monitoring in compliance with the Clean Air Act. Similar procedures are recommended for other applications as well.

Ozone standards can be classified into two basic types:

1. A **Primary Ozone Standard** is the combination of an ozone generator and an ozone monitor based on UV absorbance (a UV photometer) that has been setup in accordance with the procedures prescribed by the U.S. Environmental Protection Agency (EPA) under Title 40 of the Code of Federal Regulations, Part 50, Appendix D (40 CFR Part 50).
2. An **Ozone Transfer Standard** is a system (a portable ozone monitor and/or a portable ozone generator), which can produce accurate ozone concentration standards which are quantitatively related to a primary ozone standard. An example of an ozone transfer standard is the 2B Technologies Model 306 Ozone Calibration Source. Ozone transfer standards must be certified before use in accordance with the procedures prescribed by the U.S. Environmental Protection Agency (EPA) under Title 40 of the Code of Federal Regulations, Part 50, Appendix D (40 CFR Part 50).

5.2 Equipment Required

The equipment that is needed to carry out the calibration is commercially available, or it can be assembled by the user. Calibration using a primary ozone standard involves the generation of ozone concentrations that are simultaneously measured by a primary ozone standard and the instrument undergoing calibration. This procedure requires the following equipment:

1. Zero air source
2. Ozone generator
3. Sampling manifold (inert material such as PTFE or FEP only)
4. Sampling lines (inert material such as PTFE or FEP only)
5. UV Photometer

Use of a certified transfer standard for calibration involves the generation of ozone concentrations, using the calibrated ozone generator, that are measured by the instrument undergoing calibration. This procedure requires the following equipment:

1. Zero air source
2. Certified Transfer Standard
3. Sampling manifold (inert material such as PTFE or FEP only)
4. Sampling lines (inert material such as PTFE or FEP only)

Zero air can be generated either from compressed cylinders or from scrubbed ambient air. If ambient air is used, contaminants such as ozone and nitric oxide must be removed. Detailed procedures for generating zero air are in the EPA's [Technical Assistance Document for the Calibration of Ambient Ozone Monitors](#).

5.3 Instrument Preparation

Prior to calibration, follow the steps below:

1. Turn on the Model 106 Ozone Monitor and allow it to stabilize for a minimum of one hour.
2. Connect the instrument to the manifold on the ozone calibration setup. If a particle filter will be used in normal operation, the calibration must be performed through the filter. The manifold must be vented to atmosphere so that pressure does not build up in the calibration setup. Connection of the Model 106 directly to a pressurized output of any device can damage the ozone monitor.
3. Verify that the flow rate into the manifold is greater than the total flow required by the ozone monitor and any other flow demand drawing from the manifold.

5.4 Calibration Setup Preparation

As indicated in the EPA Technical Assistance Document, there are several tests that should be performed prior to calibration to ensure the accuracy of the measurements. These tests include:

- Setup check
- Ozone loss test
- Linearity check
- Intercomparison test

5.4.1 Setup Check

A visual inspection of the calibration setup should be performed before calibration to verify that the setup is in proper order. All plumbing connections should be checked and verified to follow the manufacturer's instructions. Any obvious leaks should be fixed and the manifold and sampling lines should be checked for general cleanliness. For more information refer to the manufacturer's User Manual for the primary ozone standard or ozone transfer standard.

5.4.2 Ozone Loss Test

Some ozone may be lost in the calibration setup due to reaction with the walls of the manifold and sampling lines. Any significant loss of ozone must be measured and be subsequently applied to correct the calibration measurements. For more information refer to the manufacturer's User Manual for the primary ozone standard or ozone transfer standard.

5.4.3 Linearity Check

Since the Model 106-M is inherently linear over several orders of magnitude, a linearity check provides a test that the instrument is operating properly. Instrument linearity can be checked by comparison to an ozone standard (see Calibration Procedure – Calibration Curve, Section 5.5.4) or by dilution of an ozone measurement. To check the instrument linearity by dilution of an ozone measurement, generate and measure a concentration of ozone near the upper range of ozone monitor (80% of full scale is recommended). Additional ozone concentrations should be generated by accurately diluting the ozone flow with zero air and each concentration should be measured once the instrument reaches a stable response. The accuracy of the linearity test relies on the accuracy of the flow meters used to perform the dilution. The percent of non-linearity is calculated from the formula:

$$R = \frac{F_o}{F_o + F_d} \quad (2)$$

$$E = \frac{C_1 + \frac{C_2}{R}}{C_1} \times 100\% \quad (3)$$

where	R = Dilution ratio	C ₁ = Measured concentration of original concentration
	F _o = Ozone generator flow	C ₂ = Measured concentration of diluted concentration
	F _d = Diluent zero air flow	
	E = Linearity error, in percent	

The linearity error should not be greater than 5%. If the error is greater than 5%, the accuracy of the flow dilution should be checked before assuming that the ozone monitor is not linear. Note that the inherent linearity of the Model 106-M is better than the error calculated in this linearity check due to the uncertainty introduced by the flow measurements.

5.4.4 Intercomparison Test

Comparison of the calibration setup with other ozone standards is a good check of the overall accuracy of the setup. If measurements from another ozone standard are found to deviate from the calibration setup greater than the instrument specifications, one of the calibration setups is not accurate.

5.5 Calibration Procedure

A multipoint calibration should be performed within the calibration frequency, any time major disassembly of components is performed, or any time the zero or span checks give results outside of the acceptable limits.

5.5.1 Instrument Preparation

1. Turn on the Model 106-M Ozone Monitor and allow it to stabilize for a minimum of one hour.
2. Enter the calibration menu (**Main Menu / Cfg / Cal / O3**) and set the zero (Z) value to 0 and the slope (S) value to 1.00.
3. Connect the ozone monitor to the manifold on the ozone calibration setup. If a particle filter will be used in normal operation, the calibration must be performed through the filter. The manifold must be vented to atmosphere so that pressure does not build up in the calibration setup. Connection of the Model 106-M directly to a pressurized output of any device can damage the ozone monitor.
4. Verify that the flow rate into the manifold is greater than the total flow required by the ozone monitor plus any other flow demand drawing from the manifold such as a UV photometer or ozone transfer standard.

5.5.2 Measurement of Zero Air

1. Verify that the zero air supply is on and the ozone generator is off. The same zero air supply used in the ozone generator must be used in the zero air measurement.
2. Allow the Model 106-M to sample zero air until the response is stable.
3. Record the average zero air response.

5.5.3 Measurement of Ozone Standards

1. Generate an ozone concentration slightly less than the concentration range of interest and allow the ozone generator to warm up for at least 5 minutes. The same zero air supply used for making zero air measurements must be used in the ozone generator.
2. Allow the Model 106-M Ozone Monitor to sample the ozone concentration standard until a stable response is measured.
3. Record the average response of the ozone monitor as well as either the average response of the UV photometer or the transfer standard.
4. Generate several other ozone concentration standards. At least 5 ozone concentration standards are recommended over the range of interest.
5. For each ozone concentration standard, record the response of the ozone monitor as well as either the response of the UV photometer or the transfer standard.

5.5.4 Calibration Curve

1. Plot the Model 106 Monitor responses (y-axis) versus the corresponding standard ozone concentrations (x-axis).
2. Fit the data to a straight line ($y = mx + b$) using the linear regression technique to determine the calibration relationships, where m =slope and b =intercept.
3. Determine if any points deviate significantly from the line, which is an indication of an error in determining the calibration curve. The error may be due to the calibration setup or the ozone monitor being calibrated. The most likely problems in the ozone monitor are leaks, a malfunctioning ozone measurement scrubber, a contaminated valve, or contamination in the optical setup. See the "Troubleshooting" section of this manual (Section 4.3).
4. The inverse of the slope of the line ($1/m$) is the gain factor (S) and the negative of the intercept ($-b$) is the offset (Z , in units of ppb, integers only) that need to be applied to the ozone monitor response to calibrate it to the primary ozone standard. If the intercept is outside of the range from -20 to 20 ppb or the slope is outside of the range from 0.90 to 1.10, this is an indication of a problem in the calibration setup or the ozone monitor being calibrated. The most likely problems in the ozone monitor are leaks, a malfunctioning ozone measurement scrubber, a contaminated valve, or contamination in the optical setup. See the "Troubleshooting" section of this manual (Section 4.3).
5. Enter the calibration menu (**Main Menu / Cfg / Cal / O3**) in the instrument software and set the calibration parameters Z and S as determined above. If the calibration has been done in units other than ppb, the offset (Z) value must be converted to ppb for entry into the instrument software.

6. PERIODIC ZERO AND SPAN CHECKS

To ensure the quality of the ozone monitor data, periodic zero and span checks can be performed by following the steps below:

1. A zero check is performed by sampling zero air with the Model 106-M as described in Section 5.5.2 above, "Measurement of Zero Air."
2. A span check is performed by sampling an ozone concentration at the high end of the concentration range of interest as described in Section 5.5.3 above, "Measurement of Ozone Standards."
3. Average measurements from the zero check or span check should be within the instrument specifications. If the measurements are not within specifications, this is an indication of problem in the calibration setup or the ozone monitor being checked. The most likely problems in the ozone monitor are leaks, a malfunctioning ozone measurement scrubber, a contaminated valve, or contamination in the optical setup. See the "Troubleshooting" section of this manual (Section 4.3).

7. LABELED INSTRUMENT PHOTOS

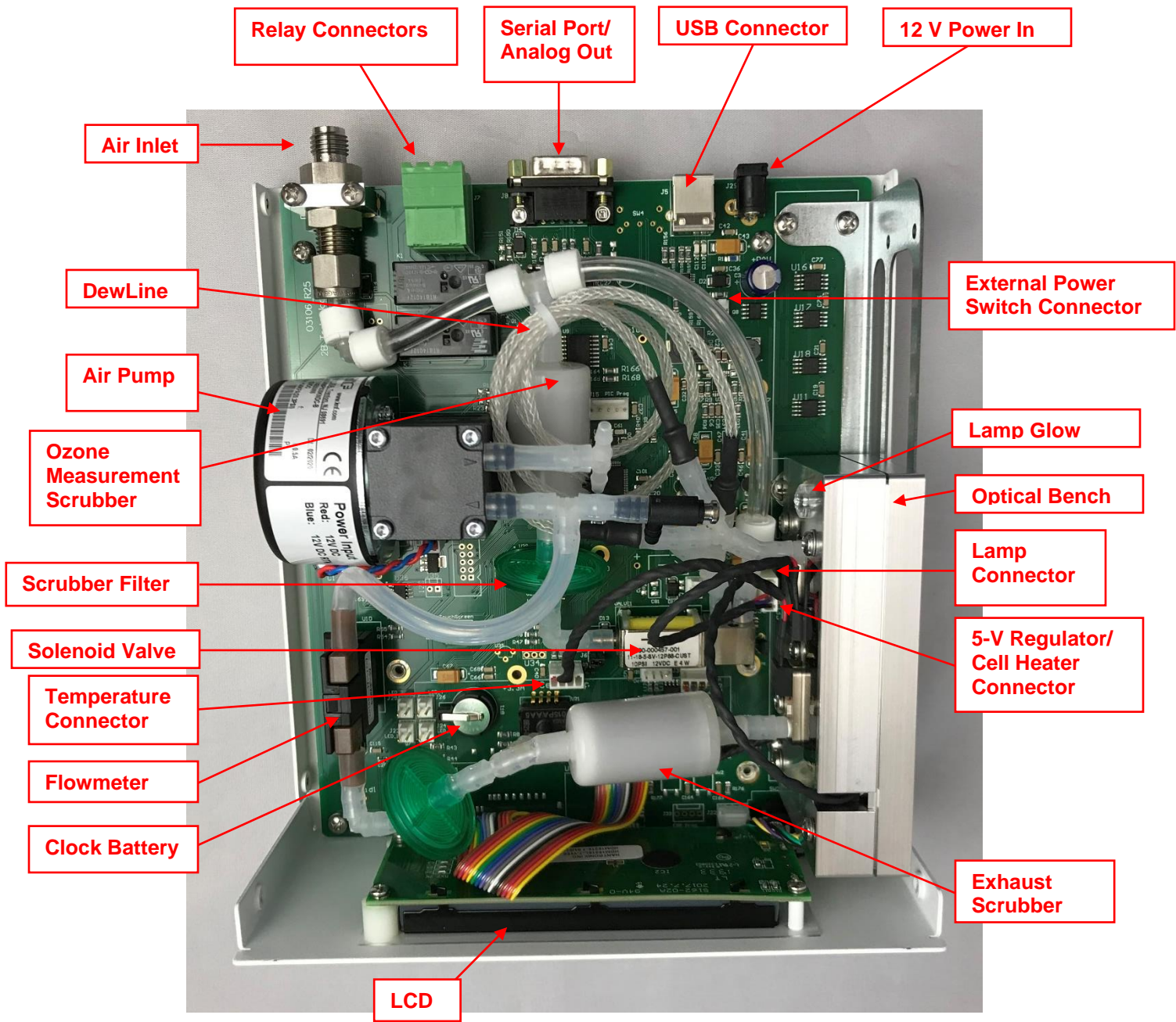

Figure 7-1a. Top View of the Model 106-M Ozone Monitor.

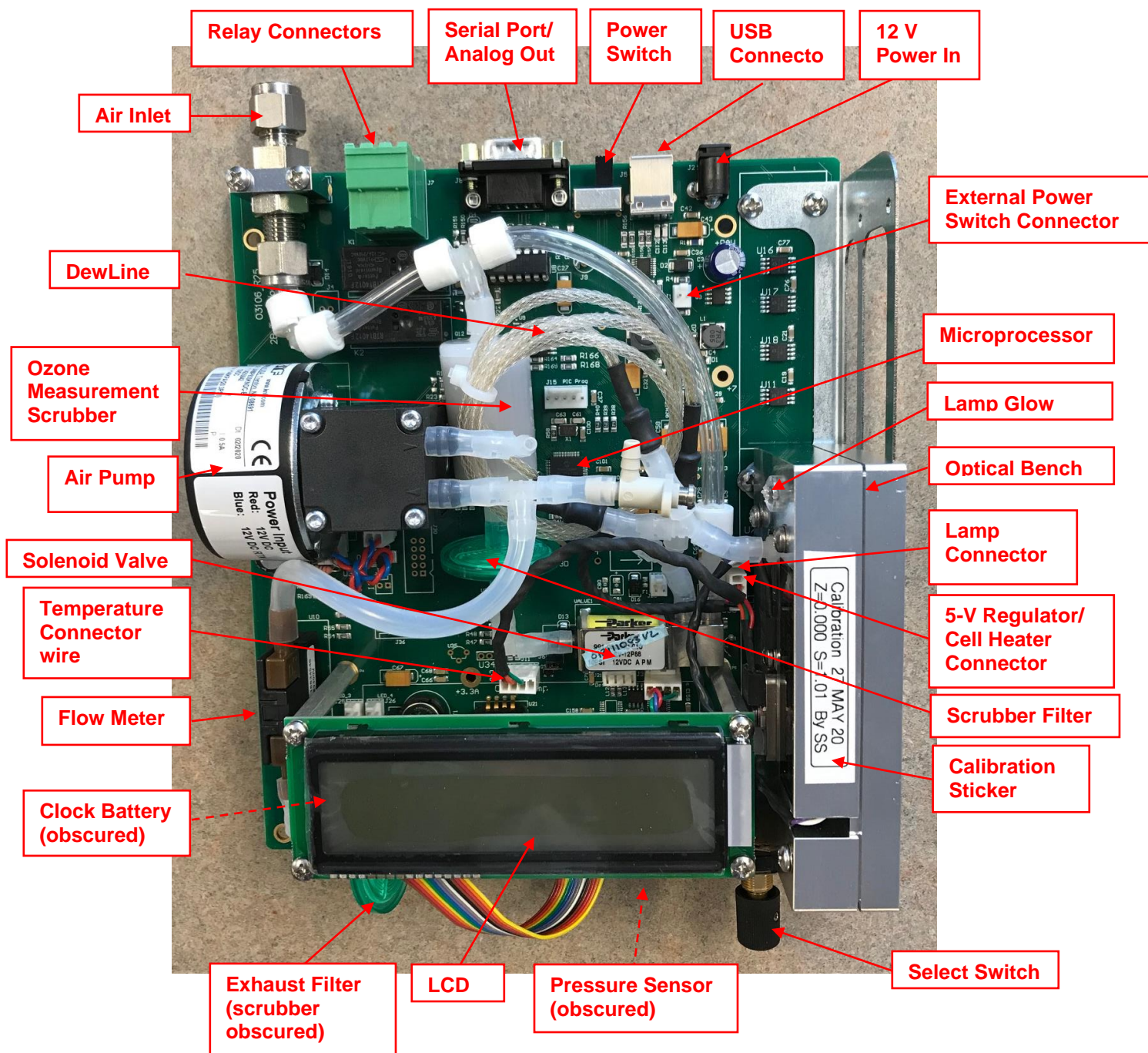

Figure 7-1b. OEM Version of the Model 106-M



Figure 7-2a. Front Cover of the Model 106-M.

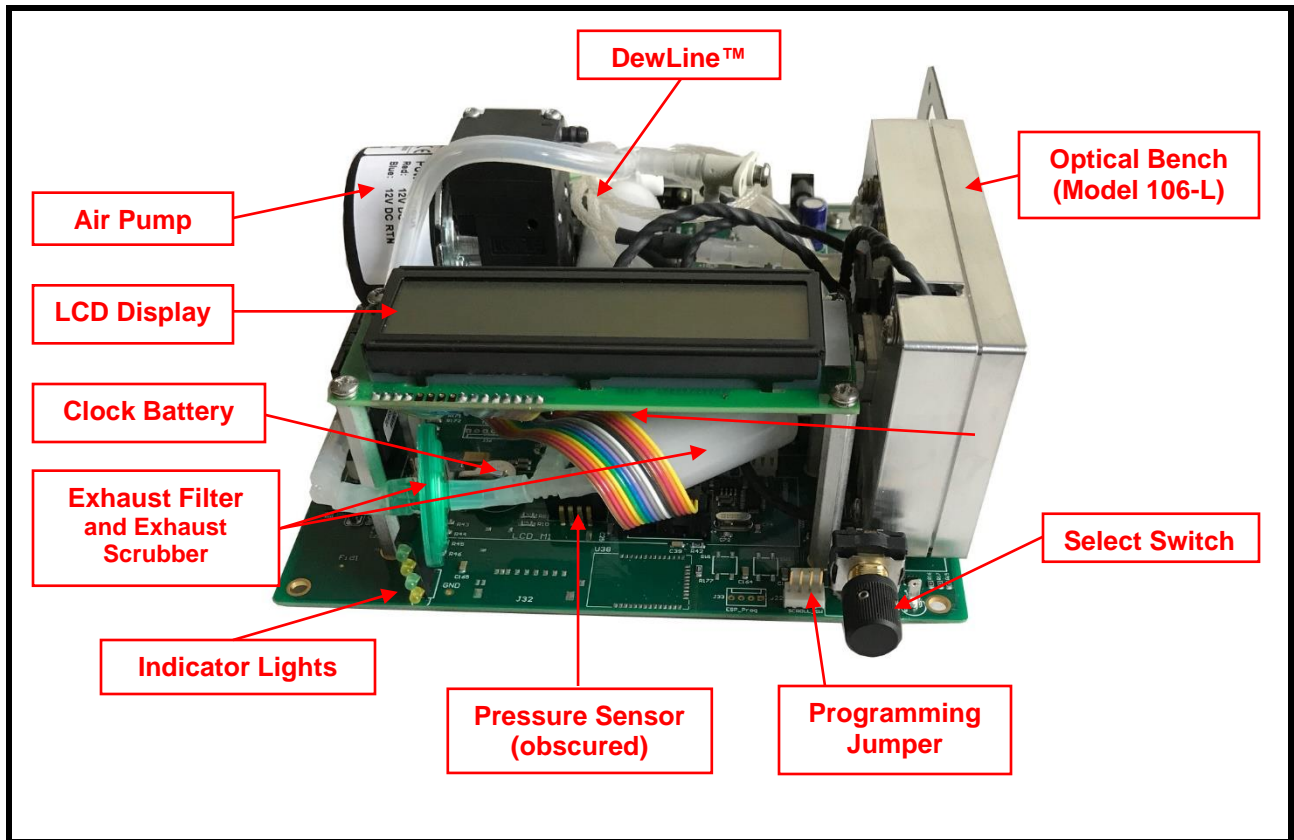

Figure 7.2b. Front view of the OEM-106-M.

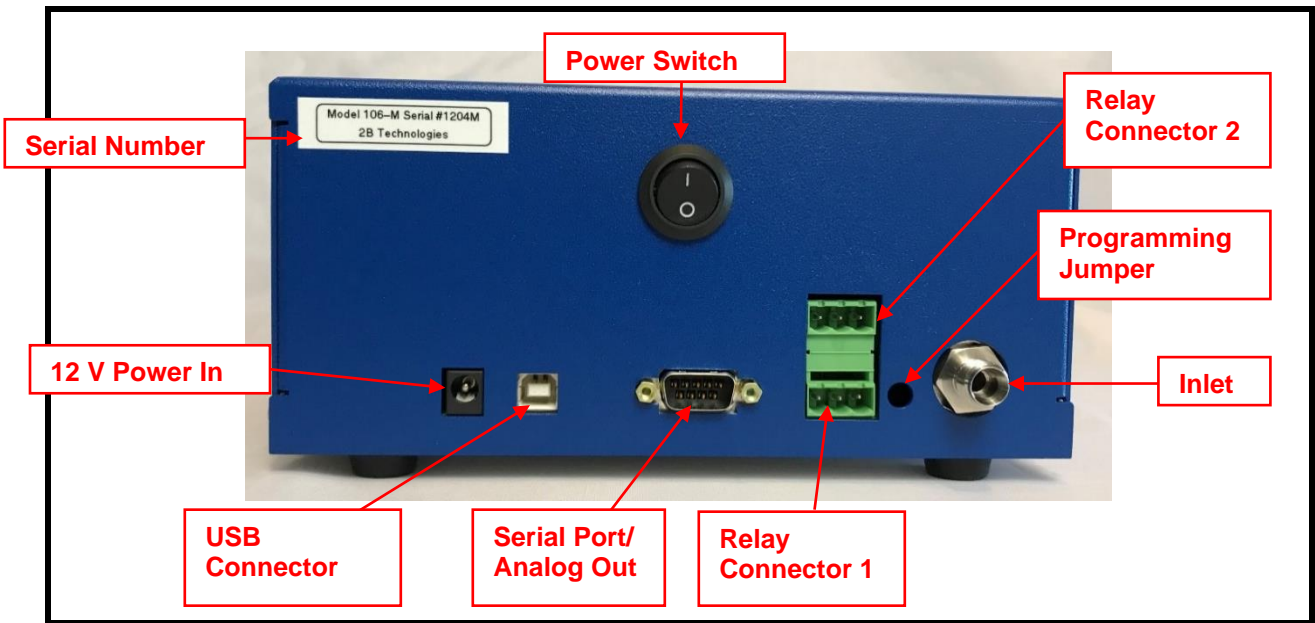

Figure 7-3a. Back Plate of the Model 106-M.

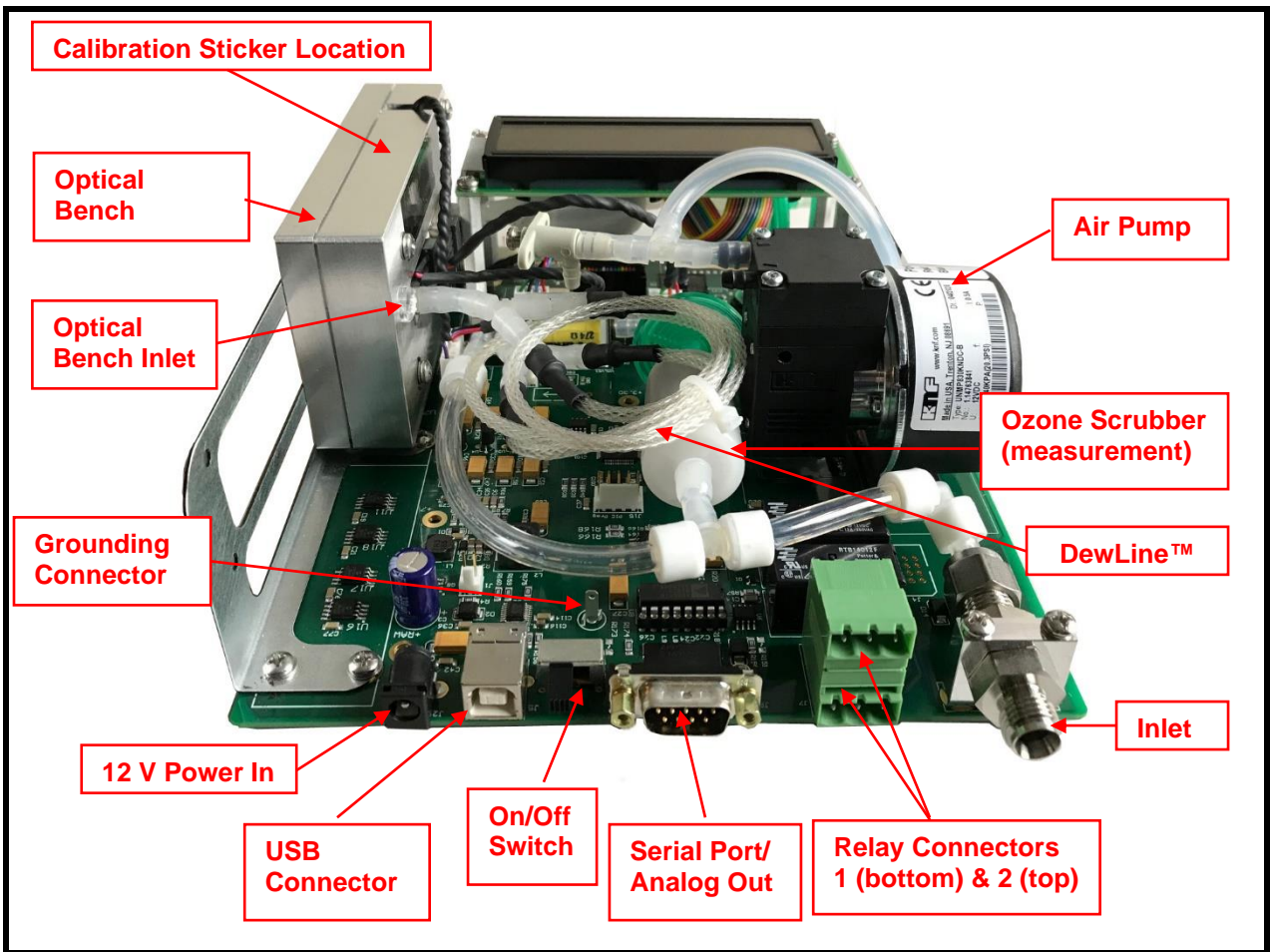

Figure 7.3b. Back view of the OEM-106-M.

8. PARTS LIST

The following list includes those parts that are user serviceable. Replacement of the solenoid valve requires a knowledge of soldering.

Please contact us for pricing and to order.

Part #	Part Name	Description
11-281	SCRBINT	Ozone measurement scrubber; ozone exhaust scrubber (internal)
10-729	SCRBEXT	Ozone zeroing scrubber (external)
11-065	OZLAMPAS106M	Lamp and inverter assembly
10-432	OZVLV106L/M	Solenoid valve
10-565	OZDSP106	LCD display and cable
10-714	OZPUMP106LM	Air pump
10-698	PDASSEMBLY106	Photodiode assembly and cable
10-575	SELECTSWITCH106	Select switch
10-587	OZCELLAS106M	Absorption cell (note, older model 106-M monitors require a different part)
10-168	FLOWMETER106LM	Flow meter assembly
10-669	DEW	DewLine™ (two Nafion tubes in parallel)
10-086	RELCON	Relay connector
11-146	RS232BRKOUT	RS232 breakout connector
10-025	SERCABL	Serial port cable (to computer)
10-030	USBCABLE	USB Cable (USB-A to USB-B 2.0 cable)
11-039	TEFTYG25	Teflon-lined Tygon® tubing (25 ft)
11-038	TEFTYG05	Teflon-lined Tygon® tubing (5 ft)
10-422	SILTUB05	Silicone tubing (5 ft)
11-352	CLEANING KIT	Cleaning kit for Model 106, 108,202, 205

Appendix A: Using the 2B Technologies Display and Graphing Software

Copyright© 2B Technologies. All rights reserved.

Introduction

2B Data Display® is an easy way to display and save data from your serial or USB connection.

With easy one-click operations, data are read from your instrument and displayed on an extremely versatile chart. Two items, such as Ozone and Temperature, can be displayed simultaneously on the chart with multiple zoom levels. Data are automatically saved to a .txt file and can optionally be saved to a .CSV file to be read in Excel. Saved data can be restored for later viewing and analyzing on the chart. By requesting an account with 2B Technologies, you can upload your data and view it on a Google Earth overlay.

Video Tutorial

A video tutorial on using 2B Data Display may be found on our website. Go to the “Software” tab of the following link: <https://2btech.io/videos/>

Downloading the Software

Go to <https://2btech.io/downloads/> and select the Software tab. Click the link for “2B Tech Display and Download Software.” Follow the instructions, doing the two installations if needed and choosing to save the “setup.exe” file. Double-click the setup.exe download to launch the 2B Data Display application.

Connecting Devices

Computer Settings

Make sure the language setting of your computer is set to “English- United States.” This ensures that the data from the Ozone Monitor is parsed correctly by the Data Display software.

Connect to an Ozone Monitor

1. Select the device you are connecting to from Settings: Select Device...
2. Click OK.
3. Select the Connection you will be using from Settings: Connection...

Choose the settings as follows:

- a) Port:
 - The default port is “COM1” for computers with a serial port.

-
- If using a USB connection, check for the correct port in the “Device Manager” under “Ports” located in: Control Panel : System : Device Manager.
 - If using a USB to Serial adapter, check for the correct port the same as for a USB connection and look for the name of the adapter (e.g., Belkin, Prolific, or other USB to Serial adapter manufacturers).
- b) Baud Rate: The Default baud rate is 2400. Check your Ozone Monitor’s settings in the “Cfg / I/O” menu and match the software with the monitor’s setting. Note that for the USB port, the baud rate must match the baud rate of the Ozone Monitor at the Monitor’s startup.
 - c) Parity: None
 - d) Data Bits: 8
 - e) Stop Bits: One
4. Click Start button in the Instrument Data Capture section in the upper left corner of the main screen.
 - a) The “Save As” window will appear. A default file name will appear which is made of the date and time. You may change the filename and change where it is saved if you wish.
 - b) Click the “Save” button. This will start the data capture software and data will fill into the chart as they are transmitted from the device.
 - c) The red OFF text will change to green ON text. The text: Waiting for data... will appear until data arrives from the instrument. If the instrument measurement frequency is set to 2 seconds, you will see a data point every 2 seconds. Averaging frequencies can be set to 10 seconds, 1 minute, 5 minutes, and 1 hour in the Avg submenu on the instrument.

Connect to Weather Station (Davis Vantage Pro)

1. Be sure the weather station is physically connected to the USB port or Serial port of the computer.
2. Select the COM port for the weather station from *Settings : Weather Connection Settings...*
3. Select “Retrieve Weather Data” from the “Weather Link” menu. A window will appear and the software will try to retrieve the weather station data. If the connection is good, weather data will be displayed in the window. If not, an error message will appear. Try a different com port if the error message appears. You may move this window so it is out of the way or you may close it. The weather data is updated every 5 seconds.
 - Since the Ozone Monitor and the Weather Station both use COM ports, you may have to unplug one of the USB adapters from the PC to determine which device is using which COM port.
4. To bring up the window again if you have closed it, select “Display Weather Data.”

Viewing Data

The Data Grid Tab

1. Make sure the application is connected to a device or that you have opened a previously saved data file.
2. Click the *Data Grid* tab on the right side of the screen.
3. The data lines received from your instrument will be listed in a grid with the latest point at the top.
4. The header contains the device specific variables (e.g., Ozone, Cell Temp...). Log Number is always listed even if your instrument is not set to log.

The Charts Tab

1. Make sure the application is connected to a device or you have opened a previously saved data file.
2. Click the *Charts* tab on the right side of the screen.
3. Select which data items to display from the drop down windows “Data 1” and “Data 2.”
4. The data points will appear in a graph window in the middle of the screen.
5. Adjust the zoom level by pressing the + or – buttons under the *Settings* button (upper right side of screen).
6. Adjust the Y scale or set the *Auto Range* feature by pressing the *Settings* button
 - a. Check the *Auto Range* box to use autoscaling.
 - b. Uncheck the *Auto Range* box to manually set Y max and Y min for the Data 1 and Data 2 fields.

The Buffer Tab

- Selecting the Buffer tab brings up a buffer window, similar to Tera Term or HyperTerminal, where all data from the serial port are displayed.
- From this tab, the user can also send commands through the serial port by typing on the keyboard. This is only applicable if the device that is connected accepts serial commands. See the instrument manual for a list of the serial commands.
- This buffer window can also be used for troubleshooting for instances when: the baud rate, device, or serial port is unknown. For example, if the status bar in the “Instrument Data Capture area states “Receiving...” and no data appear in the Data Grid or the Charts, click on the Buffer tab to view the serial data. If the correct device is not selected, no data will be displayed in the Data Grid or the Charts, but data will be displayed in the Buffer window.

Saving Data

Saving Ozone Data to a .txt File

1. Click the *Start* button in the Instrument Data Section to begin collecting data from the instrument.
2. A window will pop up to prompt for the name and location of the file.

-
3. Click *Save* to begin the data collection.
 4. All data read from the ozone monitor through the COM port are written to the .txt file in real time until *Stop* is clicked.

Saving Data to a .CSV or an Excel File

NOTE: Weather data are NOT saved to the .txt file. In order to save weather data, be sure to save a .CSV file after *Stop* is clicked.

1. After collecting data, click the *Stop* button in the Instrument Data Capture Section on the main screen.
2. A window will pop up to ask you if you would like to save to a CSV file as well. Click *Yes*.
3. A default name appears from the date and time of the data capture. You may change the name and path of the file if you wish.
4. Click on the *Save* button.

Opening Files

1. To open a file, click *Open* from the *File* menu.
2. Navigate to the folder where the file was stored.
3. Select either the .txt file or the excel file and press *Open*.
 1. NOTE: To view weather data, you must open the corresponding .CSV file.
4. Choose the correct device associated with the file.
 - a. If you are unsure, open the file in a text editor or Excel to determine which device.

Serial and USB Commands

The menu commands are the same as given in Section 3.15 of this manual.

Appendix B: Model 106-M Cleaning Procedures (Flow Path)

Summary:

It is recommended that Ozone Monitors be returned to 2B Tech at least once annually for calibration. This includes cleaning of the entire flow path and installation of a new internal ozone measurement scrubber (Figure 7.1). If the flow path becomes contaminated, as evidenced by large positive or negative offset (Z) and/or low slope (S) calibration parameters, it may be necessary to clean the flow path and replace the ozone measurement scrubber. This can be done by the user if desired. The procedure involves the following steps:

1. Remove the top cover.
2. Bypass the ozone measurement scrubber.
3. Bypass the DewLine™ (Nafion tube).
4. Connect a drain tube at the exit of the detection cell.
5. Squirt methanol through the flow path while the instrument is running.
6. Blow dry with clean compressed air or nitrogen while the instrument is running.
7. Check the DewLine™ for contamination.
8. Replace the ozone measurement scrubber.
9. Reconnect plumbing.

Tools needed:

- Philips head screw driver
- Teflon®-lined Tygon® or other clean, inert tubing such as PTFE, PFA or PVDF
- Methanol (methyl alcohol)
- Squirt bottle
- New ozone measurement scrubber

Please refer to Figure 7.1 of this manual as you go through this cleaning procedure.

Warning: This procedure makes use of the toxic and flammable solvent methanol, and appropriate care should be taken. Although a relatively safe solvent to work with, as with all solvents appropriate care should be taken. Remove any clothing contaminated with methanol. If methanol contacts your skin, wash the affected areas with soap and water for at least 15 minutes. If methanol gets in your eyes, wash your eyes with water for at least 15 minutes, occasionally lifting and lowering the upper and lower eyelids and seek medical help.

Model 106-M



Procedure:

1. Remove 6 screws from top cover. Remove cover (blue) from base (white).

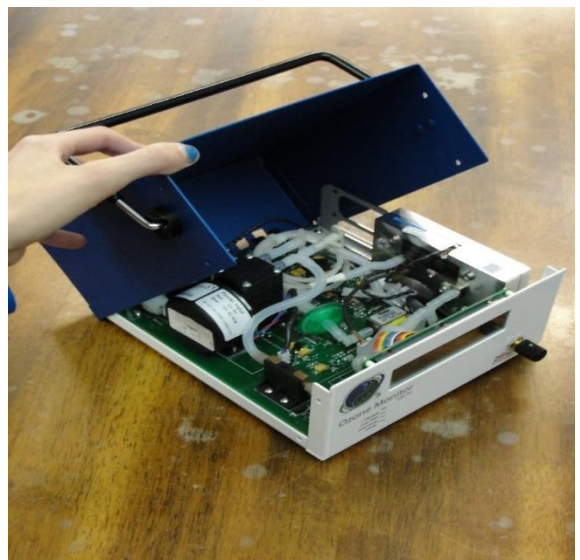

-
2. Bypass the ozone measurement scrubber and disc particle filter by disconnecting both ends of the scrubber and replacing with a short piece of clean, inert tubing such as Teflon-lined Tygon®, PTFE, PFA or PVDF. **Do not use Tygon!**

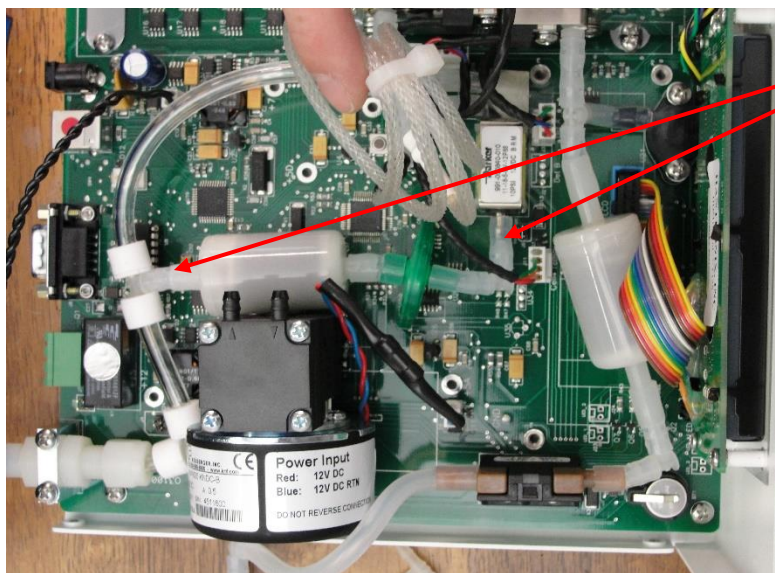

Disconnect at these 2 points

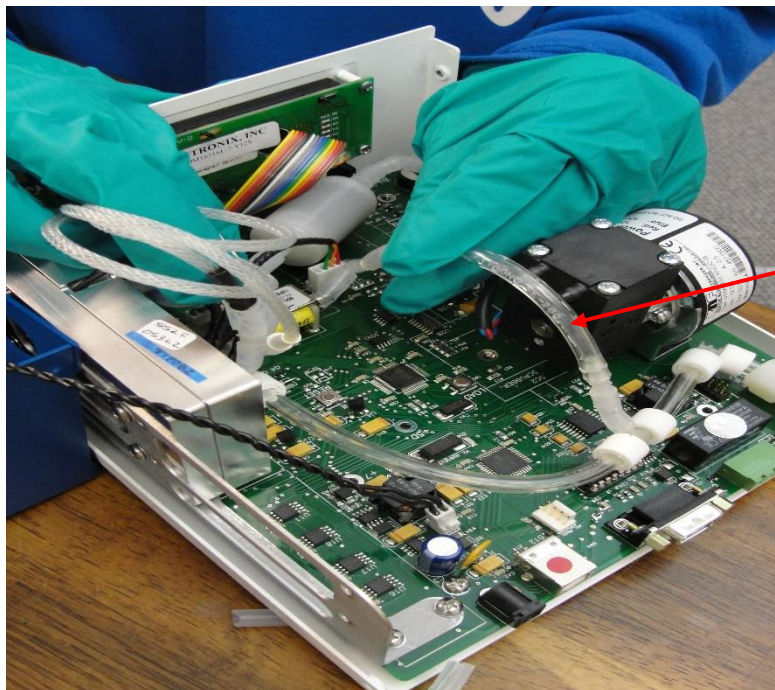

Scrubber bypass tubing

3. Remove the DewLine™ at both ends and replace it with clean, inert bypass tubing such as Teflon-lined Tygon®, PTFE, PFA or PVDF. **Do not use Tygon!**

Note that the DewLine™ consists of two sections of Nafion® tubing connected in parallel.

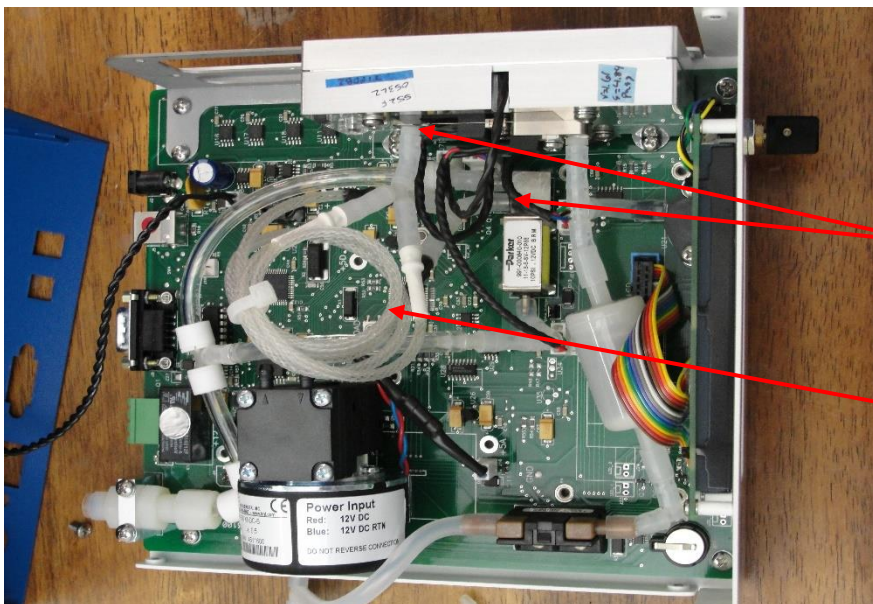

Disconnect at the barbs at these 2 points

DewLine™

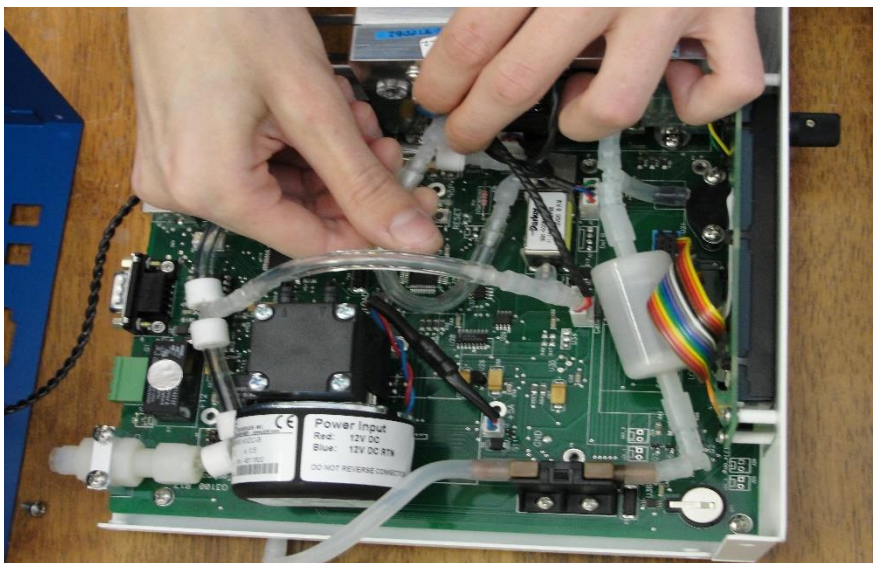



DewLine™ bypass tubing

4. Disconnect the tubing from the outlet of the detection cell and replace with a drain tube. This can be any kind of tubing; silicone tubing is shown here.

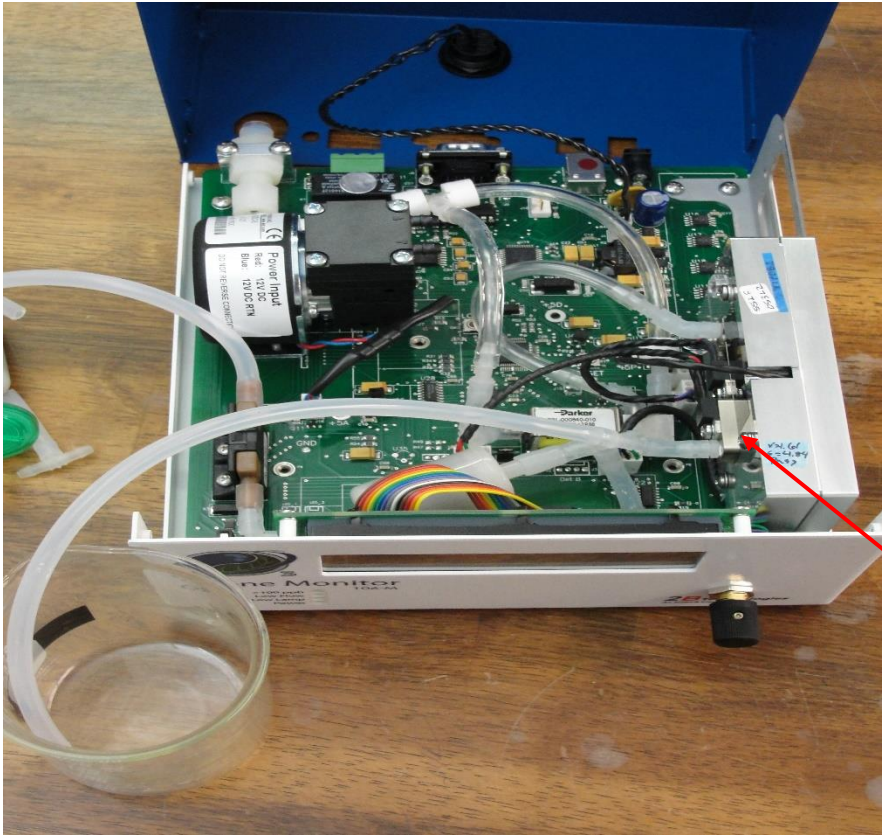

Another view.

Disconnect here, at the barbed connection that is on the side of the detection cell.

5. Put on goggles and plastic or rubber gloves. Carry out the cleaning procedure in a hood or well ventilated area. Make sure there are no sparks or flames nearby.

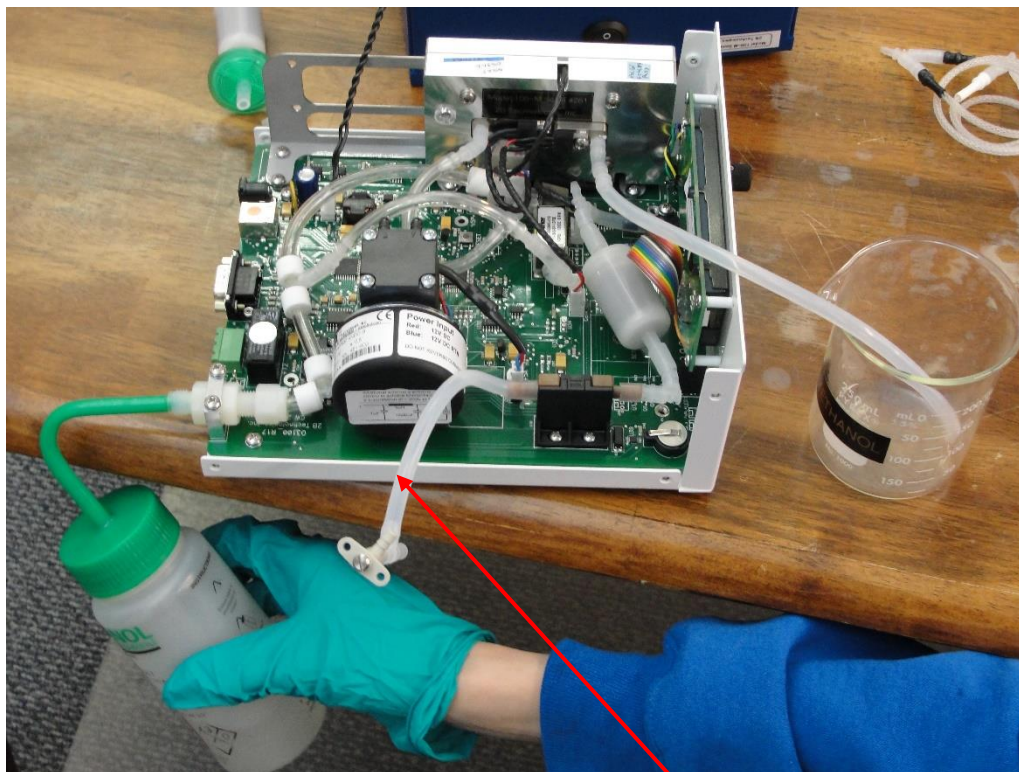

Note that we have removed this pump connection tubing for clarity in taking the photos.

Use a squirt bottle to force methanol through the flow path while the instrument is running. You should pass at least 50 cc of methanol through the instrument. The purpose of having the instrument running is to clean both sides of the 3-way solenoid valve. This valve switches states every 2 seconds.

Collect the waste solvent and dispose of properly. Don't pour methanol down a drain.

6. Dry the flow path with clean, compressed air or nitrogen. Be careful during this step and use low pressure to begin with as large quantities of methanol will spew out initially. **IMPORTANT:** It is necessary that the flow path be completely dry before reconnecting the scrubber.
7. If the DewLine™ has become contaminated (as noted by discoloration), it should be replaced, or returned to 2B Technologies for cleaning.
8. It is recommended that you replace the ozone measurement scrubber (the one you bypassed) during this step. If the flow path was dirty, then the scrubber will be dirty as well. A contaminated ozone measurement scrubber will typically cause a large

offset in the measurement and may re-contaminate the flow path. The ozone exhaust scrubber on the opposite side of the instrument that protects the air pump may be changed at this time as well, although that ozone scrubber has no effect on the ozone measurement.

9. Reconnect the plumbing and replace the instrument covers. The assembled Model 106-L instrument is shown below as a guide (differs from the 106-M in having a longer optical bench and some slight differences in plumbing).

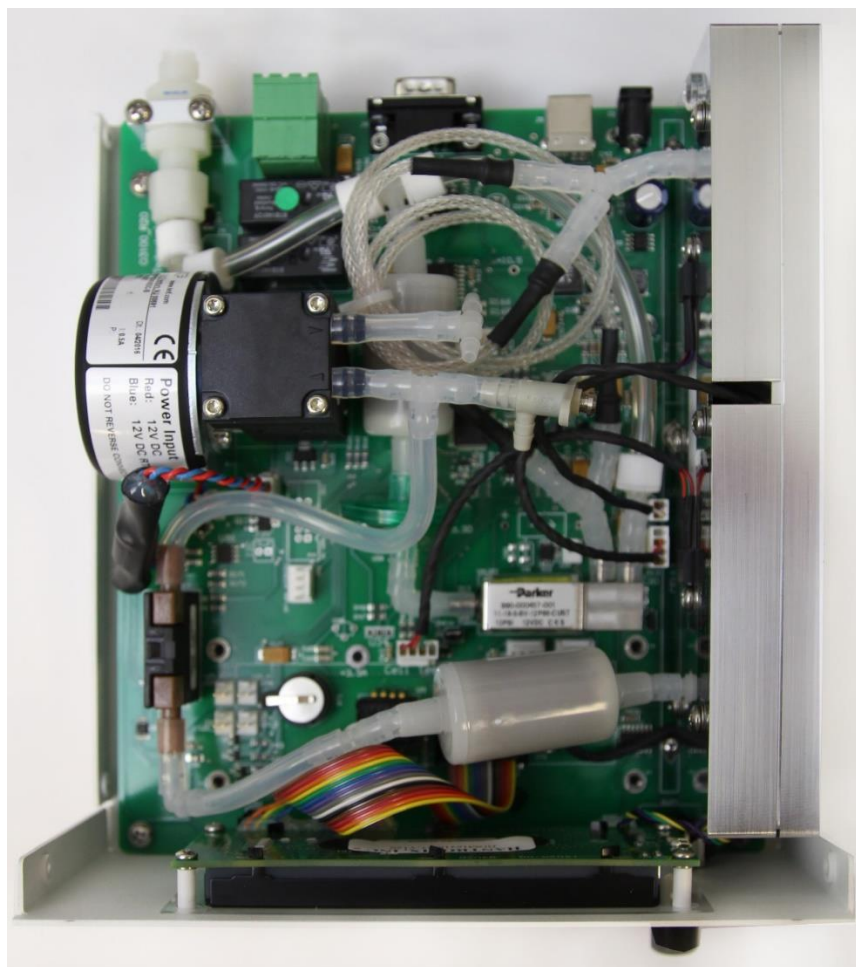

10. We recommend that you run the instrument at least an hour or two after cleaning, to ensure that it is thoroughly dry before you resume measurements. Place an external ozone scrubber on the Model 106-M air inlet for this step.

Additional Cleaning:

When calibrated, the 106-M Ozone Monitor should have an offset (Z) in the range ± 20 ppb and preferably ± 10 ppb. The slope calibration parameter (S) should be in the range 0.90-1.10 and preferably 0.96-1.06. Offsets and slopes outside this range are most often due to a contaminated flow path. Sometimes it requires more than one cleaning to correct a highly contaminated instrument. If methanol alone is not adequate, it is helpful to do a first cleaning with hexane and a second cleaning with methanol. All of

the cautions concerning the use of methanol apply to hexane as well. If cleaning of the flow path in combination with replacing the ozone measurement scrubber does not correct the problem, please return the instrument to 2B Technologies. We will provide you with an estimate of any required repairs before doing the work.

If you have an ozone source, it is helpful to 1) clean the instrument with methanol, 2) expose the instrument to high ozone levels (ppm and above) for several minutes to hours, and 3) clean the instrument again with methanol. The ozone will oxidize contaminants to form polar oxygen-containing compounds that are more soluble in methanol.

Note: You can check the zero of the instrument by running it with an external ozone scrubber attached. Keep in mind that the external ozone scrubber must be clean; otherwise, it will desorb UV-absorbing compounds and cause an apparent offset.

Appendix C: Installation and Use of the USB Connection (for older versions of the Model 106 and/or Windows)

The following procedure describes how to install and use the USB connection for earlier versions of the Model 106-M (those having 1 relay rather than 2 relays, serial numbers below 1004M) and/or for PC computers running earlier versions of Windows.

Items Required

- USB-A Type to USB-B-Type Cable
- Model 106-M Ozone Monitor (older version, 1 relay, serial number <1004M)
and/or
- PC Computer with Windows 2000, XP, Vista, or earlier

Driver Installation

1. Download the 106 USB driver from 2B Tech's website, <https://2btech.io/downloads/>
2. Navigate to the folder labeled "cdc_NTXP" and double click on it.
3. Unzip the contents to a folder on the desktop or any area you wish.
4. With the Model 106 off, attach the USB cable from the Model 106 to a USB port on the computer.
5. Turn on Model 106. The install wizard should pop up as follows. Select "No, not this time" and click "Next".

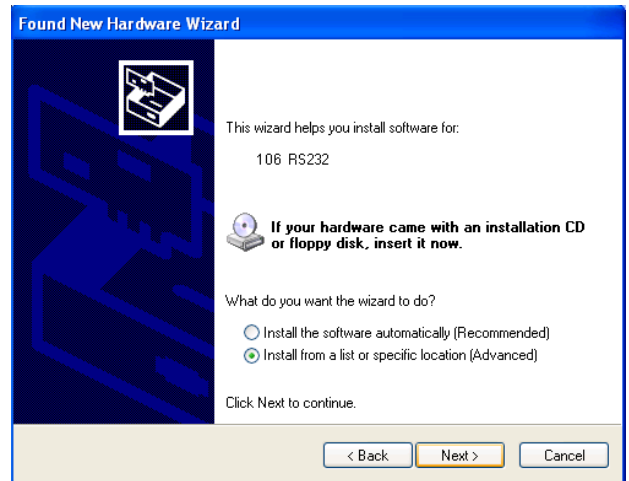

6. In the new popup window, select the "Install from a specific location" option and click "Next".

7. Navigate to folder where you unzipped the cdc_NTXP.

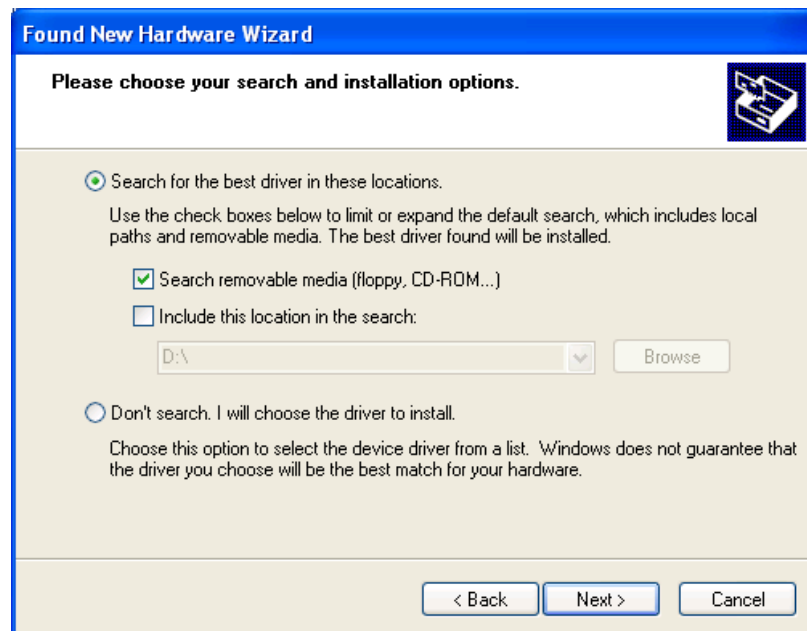

8. Select "Continue Anyway" when this window appears.



9. After a few seconds, the driver will be finished installing.

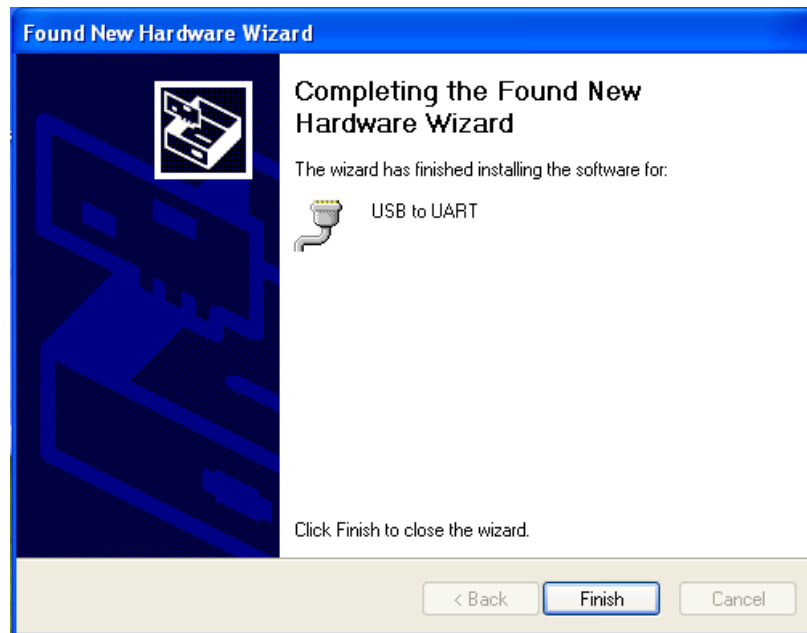

Determine the Connection Port

After installation is complete, determine which COM port the connection is using. This can be done by the following procedure.

1. If using Windows (XP,Vista,7), go to the control panel and select “System.”
2. Click on the “Hardware” tab.

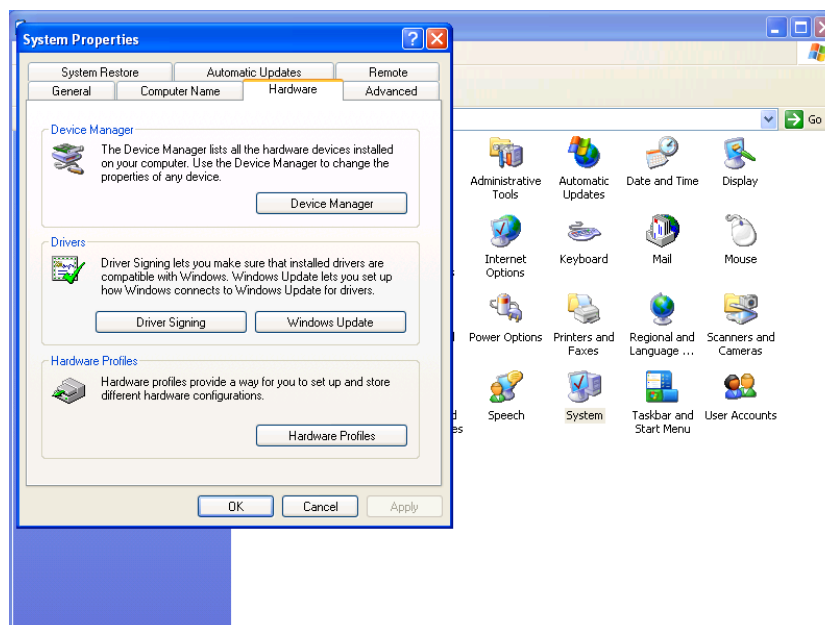

3. Click the “Device Manager” button.
4. Press the “+” sign next to “Ports”.

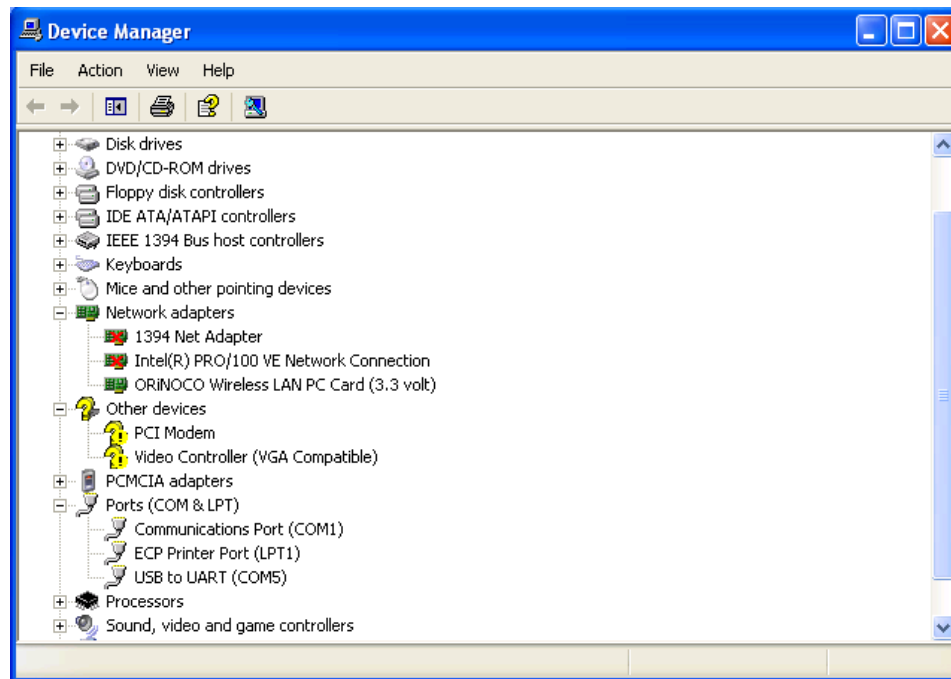

5. In Parenthesis, next to the “USB to UART” listing is the assigned COM port number. This number will be used for the settings for the Terminal emulator or software used to read data from the Model 106.

Using the Connection

- Plug the USB cable in after the powering the Model 106 to ensure correct functionality.
- When setting up your software or terminal emulator, choose the correct com port listed in the Device manager.
- Use these baud rate settings: 2400, 8 bits; no parity; 1 stop bit.
- Use [2B Technologies Display and Graphing Software](#) or other software (such as HyperTerminal or [Tera Term](#)) to read measurement data from the Model 106.

Appendix D: Operation of the Multi-Channel Model 106-M Ozone Monitor

D.1 Introduction

This appendix describes the multi-channel versions of the Model 106-M Industrial Ozone Monitor. Two multi-channel configurations are available: 3-channel and 6-channel. These configurations enable automatic or manual sampling of multiple air streams. The multi-channel Ozone Monitor is inside a wall-mount enclosure that is suitable for wall or rack mounting in your air sampling system (Figure D-1). The shatter-proof window provides for viewing the instrument display and status lights through the closed door. A 1/4" inch compression fitting is provided for the sample inlets on all the Series 106 Ozone Monitors.

Operation of the Model 106-M-MC3 and Model 106-M-MC6 multi-channel Ozone Monitors is completely analogous to the operation of the single-channel Model 106-M. The reader is referred to the main body of this manual for detailed descriptions, warranty policies, safety warning, etc., all of which apply to the multi-channel instruments and will not be repeated here. This appendix will highlight the differences in the instruments and focus on describing the use of the multi-channel features.

For additional drawings and instructions, please see the Installation manual for the Model 106 Industrial Ozone Monitors, posted on our website:

[Model 106 Industrial Installation Manual with Drawings](#)



Figure D-1. Multi-channel configuration of the Model 106-M Ozone Monitor (front and bottom views).

D.2 Specifications of Model 106-M-MC3 and Model 106-M-MC6

Differences from the standard single-stream Model 106-M are shown in blue font.

Measurement Principle	UV Absorption at 254 nm, single beam
Multi-Channel Configuration	3-channel or 6-channel configuration
Measurement Time and Frequency	10 s, 0.1 Hz
Data Averaging Options	1 min, 5 min, 1 hr
Response Time, 100% of Step Change	For 10 s output: 20 s, 2 data points
Linear Dynamic Range	0-1000 ppm (1,000,000 ppb)
Resolution	0.01 ppm
Precision (1σ) for 10-s output (rms noise)	Greater of 0.01 ppm or 2% of measurement
Limit of Detection (2σ)	0.02 ppm (20 ppb) for 10-s output
Accuracy	Greater of 0.01 ppm or 2% of measurement
Baseline Drift	< 0.01 ppm/day, < 0.03 ppm/year
Sensitivity Drift	< 1%/day, < 3%/year
Calibration	NIST Traceable, annual calibration recommended
Data Logger Capacity	32,736 lines (10-s meas. = 3.8 days; 1-min avg. = 22.7 days; 5-min avg. = 113 days; 1-hr avg. = 3.7 yr)
Data Transfer Baud Rates	2400, 4800, 19200
Ozone Units	ppb, pphm, ppm, $\mu\text{g m}^{-3}$, mg m^{-3}
Pressure Units	mbar, torr
Temperature Units	$^{\circ}\text{C}$, K
Temperature and Pressure Corrected	Yes
DewLine™ for Humidity Control	Yes
Power Requirements	100-240 VAC, 50/60 Hz; 11-28 VDC, nominally 560 mA at 12 V, 6.7 watt
Operating Temperature Range	0 to 50 $^{\circ}\text{C}$
Flow Rate	Minimum Required: 0.3 L/min; Nominal: 1 L/min; Maximum: 1.5 L/min
Digital Data Outputs	RS232, LCD display
Relays with 2 Set Points	Four available: Relays 1 through 4 respond based on user's ozone set points for Channels 1 through 4, respectively. Relay 2 alternately can be set to respond based in instrument diagnostics (T, P, flow, lamp voltage).
Bluetooth	Optional

Size	Door closed: 14" w × 16" h × 9.3" d (25.7×40.7×23.6 cm) Door open: 14" w × 16" h × 21.6" d (25.7×40.7×54.8 cm)
Weight	~14 lb (4.8 kg) depending on configuration purchased
Options	Battery, Particle Filter, Bluetooth

* Not available on the multi-channel configurations of the Model 106-M Ozone Monitor:
Adaptive filter; USB; adjustable analog output.

D.3 Installation and Startup

Open the shipping box and verify that it contains all of the items on the shipping list. If anything is missing or obviously damaged, contact 2B Technologies immediately.

Secure the instrument to your system. The multi-channel ozone monitor is constructed inside a polyester enclosure. Use the brackets on the top and bottom of the back of the monitor (Figure D-2) to secure it to your system.

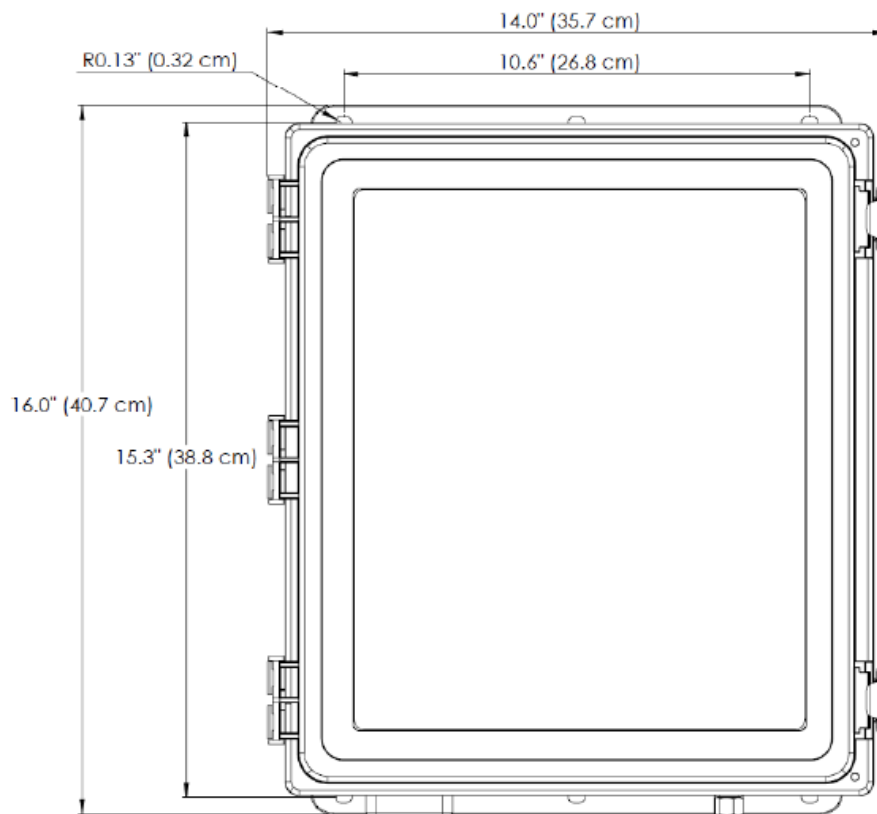

Figure D-2. Dimensions of the enclosure and mounting brackets of the Model 106-M-MC6/MC3.

Connect the monitor to an external power source. The NEMA 4X Industrial units, including the multi-channel units, are set up for AC power via connection to an AC/DC converter mounted on the baseplate (red dashed rectangle in drawing of Figure D-3). These units are intended to be installed by electricians using conduit to bring electrical power to the unit. A 1/2" conduit connector, supplied by the user, should be installed on the enclosure through the hole provided in the enclosure bottom (red circle in drawing of Figure D-3). In order to maintain the NEMA 4X rating of the enclosure, an appropriate sealed conduit connector should be used. Alternatively, the customer can use a 12VDC power supply and bring the power cable into the box through either a conduit fitting or a 1/2" cable gland. The power requirement is 100-240 VAC, 50/60 Hz, 11-28 V DC, nominally 500 mA at 12 V DC, 6 watt.

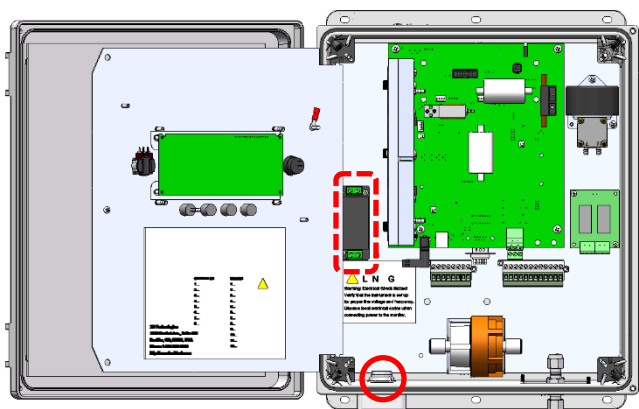

Figure D-3. Instrument layout and power points.

Establish the inlet connections. Inlet tubing may be attached to the 1/4-inch stainless steel Swagelok fittings on the side of the enclosure (Figure D-4; 3 or 6 fittings, depending on the instrument you have purchased). The inlet tubing should be made of PTFE (Teflon®), PFA, FEP, PVDF or some other inert material that does not destroy ozone and that does not desorb plasticizers and other organics that can contaminate the flow path. The length of tubing should be kept as short as possible (preferably not more than a few feet) to minimize ozone destruction within the inlet tubing. Tygon®, polypropylene (which may look like Teflon) and metal tubing should not be used. FEP-lined Tygon tubing, which is used inside the instrument, provides the flexibility of Tygon with the inertness of FEP. A particle filter inside the instrument helps to prevent internal contamination of the tubing and absorption cell by particulate matter. If the user anticipates that especially dirty air will be sampled in one or more channels, an additional Teflon or PDVF external filter could be added outside the instrument to protect the sampling valve(s). The filter should be tested for ozone loss by measuring ambient ozone with and without the filter attached. Filters and filter holders are available through 2B Technologies. **Caution: Do not pressurize the inlet.**

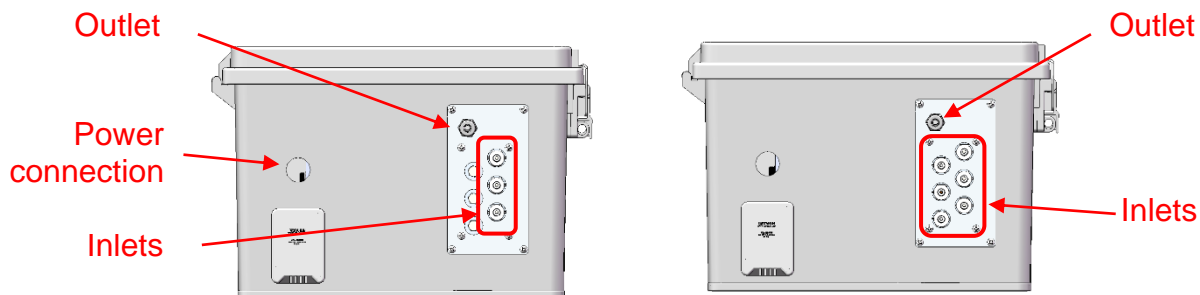

Figure D-4. Electrical connection point, outlet, and inlets on the bottom of the Model 106-M-MC3 and Model 106-M-MC6.

Establish the exhaust outlet connection. The Ozone Monitor has an interior ozone scrubber prior to the exhaust. However, it is recommended that the outlet of the instrument (Figure D-4) be vented properly and away from personnel, in case the scrubber's capacity is exceeded (for example, for very high ozone concentrations, or if the scrubber needs replacement).

Important recommendations.

- As mentioned later in this appendix, the user can specify how many of the instrument's channels will be used for sampling. **To prevent damage to the instrument's internal pump, we recommend that unused inlets remain unobstructed/uncapped.** That way, the user cannot inadvertently begin sampling from a port that is obstructed.
- **Caution: Do not pressurize the inlet of the instrument.** It will damage the instrument. Use a tee to vent at the inlet if you are providing a flow to the instrument.
- Although the instrument compensates for temperature drift, if strong temperature fluctuations are expected, the instrument should be thermally insulated.
- Periodic zero and span checks, and annual calibration, are recommended.

Allow 20 minutes for warmup. Once properly installed as outlined above, the instrument may be turned on. The instrument will display the version number of the software installed on the microprocessor and the instrument serial number. After a few seconds, the instrument will start displaying readings for ozone. The first dozen readings (requiring about two minutes) will be spurious, with large positive and negative swings due to the rapid warmup of the lamp and electronics. Also, ozone readings may be inaccurate during the 10-20 minutes required for the lamp, photodiode, and internal temperature of the absorption cell to stabilize. Four LEDs on the front panel indicate whether the instrument is powered on (right LED), if flow and lamp voltage are adequate (middle two LEDs), and if measured ozone exceeds 100 ppb (left LED). Allow 20 minutes for instrument warmup before taking measurements.

Default Settings. When shipped from the factory, the instrument has the following default settings: Avg=10 s, T in °C, P in mbar, O₃ in ppm, auto sampling mode, duration=6 measurements, dwell=10 s, max channels=maximum number (3 or 6), manual channel=1.

Use with Ozone Generators. If using the Model 106-M Ozone Monitor downstream of an ozone generator, it is important to use dry oxygen (not air) as the feed gas for the ozone generator. This will avoid production of corrosives such as nitric acid, which will damage 2B Tech's low-concentration Ozone Monitors (such as Models 106-L and 106-M). Please see our [Tech Note #49](#) on this topic.

D.4 Summary of Operating Recommendations

The following table gives a summary of the operating recommendations mentioned in this manual:

Summary of Operating Recommendations

Operating Recommendation	Frequency	Section Reference
Allow ~20 minutes for instrument warmup before taking data	Each startup	3.2, D.3
Inlet tubing should be made of inert materials, such as PTFE, PFA, FED, PVDF (do not use Tygon®, polypropylene, or metal tubing)	Each use	3.2, D.3
Unused inlet(s) should be unobstructed/ uncapped to prevent inadvertent damage to the internal pump	Each use; for standard instrument and multi-channel	D.3
Check the zero offset	Occasionally	3.10, 6
Perform multipoint calibration	<ul style="list-style-type: none"> • Annually • Any time major disassembly of components is performed • Any time the zero or span checks give results outside of the acceptable limits 	5
If strong temperature fluctuations are expected, place the instrument in a thermally insulated box	User-defined	3.2, D.3
If using the Model 106 Ozone Monitor downstream of an ozone generator, use dry oxygen (not air) as the feed gas for the ozone generator so that corrosives will not be produced by the ozone generator.	Especially important for low-concentration Monitors 106-L and 106-M	D.3
Do not pressurize the inlet of the instrument. Use a tee to vent at the inlet if you are providing a flow to the instrument.	Each use	3.2, D.3

D.5 The LCD Display During Measurements

During normal measurements, the LCD display of the Model 106 multi-channel instruments differs slightly from the single-channel instrument. The channel number currently being sampled is displayed in the upper left corner of the alternating display screens, for example if channel 2 is being sampled:

C2 O3=63.27 ppm
13:29 26/09/20

where the current O₃ measurement is 63.27 ppm (by volume), the time in 24-hour format is 1:29 pm, and the date in European format is September 26, 2020. The time/date display will alternate with two additional displays, for example:

C2 O3=62.07 ppm **C2 O3=62.24 ppm**
T=26.9 P=923.5 **F=850 V= 1.433**

where the cell temperature is 26.9°C, the cell pressure is 923.5 mbar, the air flow rate is 850 cc/min, and the photodiode voltage is 1.433 volts. (See Section 3.9 of the main part of the manual for choosing other units for T, P, and O₃.)

When the instrument is transitioning between channels (i.e., in the “Dwell” period; see Section D.6.2 below), the ozone measurement line of the display is replaced by, for example:

Channel 2 Dwell

If averaging for 1 min, 5 min, or 1 hour has been selected (**Avg** submenu), the display of the most recent average value alternates with the most recent ozone measurement, for example:

Avg O3=54.1 ppm

If logging has been selected (**Dat** submenu), the time/date is no longer displayed in the alternating screens. Instead, the current log number and number of samples acquired for the next average are displayed. For example, the display might read:

Avg O3=54.15 ppm
Log= 193:4

where **Avg O3** is the average ozone value most recently written to the logger, and the current log number is 193. The “4” in 193:4 refers to the number of 10-s data points that have been measured so far for inclusion in the next average to be displayed and logged. If 1-min averaging is used, this number will increment from 0 to 5; for 5-min averaging, the number will increment from 0 to 29; and for 1-hr averaging, it will increment from 0 to 359. This number is displayed so that the user will know how many more 10-s measurements need to be made before a new average is displayed and logged.

Note that if the LCD or serial menu is entered when an average is in progress, that unfinished average value will be lost and a new average will be started when measurements are resumed.

D.6 LCD Menu Operation

D.6.1 The LCD Menu Tree

Many aspects of the Ozone Monitor's operation may be accessed from the LCD menu. The menu tree of the multi-channel instruments is shown below. Differences from the single-channel Model 106-M are shown in blue font (the **Mch** submenu and Relays). Note that because of this change, the Lamp Test is accessible only from the serial menu for the multi-channel instruments.

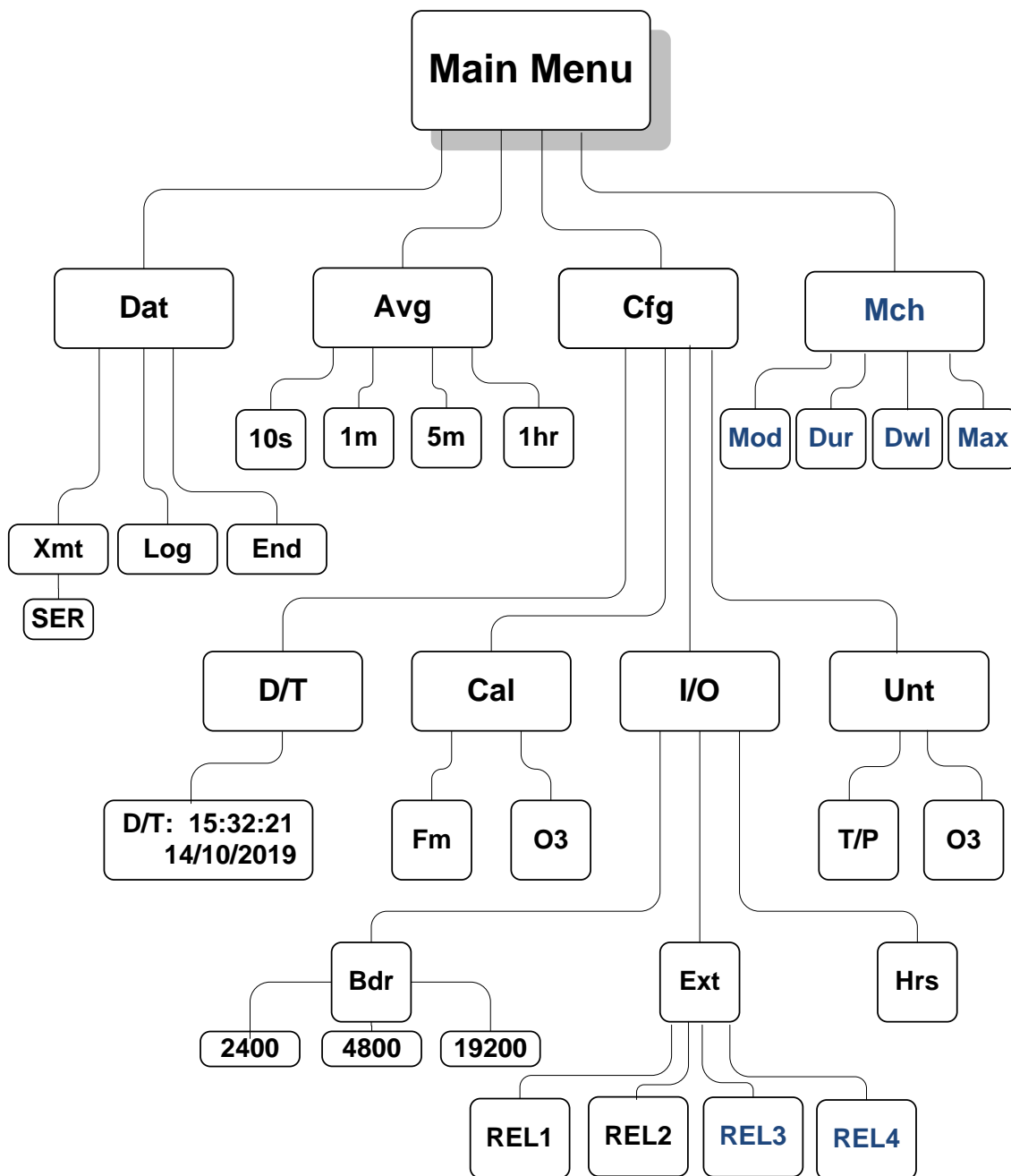

D.6.2 The Multi-Channel Submenu (Mch)

During normal operation, press and hold in the Select switch to enter the Main Menu. Rotate the Select switch until the cursor is under the **Mch** submenu, and press the Select switch in to enter the submenu. Four submenu choices then appear:

Multi Ch Menu
Mod Dur Dwl Max ←

Selecting the Mode (**Mod**) submenu allows you to select either automatic or manual as the operation mode for the multi-channel switching:

Set Mode
Auto Manual ←

Selecting **Auto** will sample each channel for the number of measurement intervals (6 to 36) specified in the Duration (**Dur**) submenu and then switch automatically to the next channel. For example, if the user selects 6 for the duration and the average output is set to 10 seconds, the channel will change every 6 measurements or 60 seconds. If the average output is set to 1 minute, and the duration is set to 6, the channel will change every 6 minutes. The transition period between channels, Dwell (**Dwl**), can be set in the range of 0 to 30 seconds. The purpose of the Dwell period is to allow for flushing of the inlet line from the current channel. The longer the inlet lines, the longer the Dwell time should be set to. Data are not retained or averaged during this transition period. Use the Select switch to move the cursor and make the desired selections for Duration and Dwell.

Note: During the Dwell period, the serial output is suspended.

Selecting **Manual** will enable the operator to specify the sampling channel via the next screen that appears:

Select Channel
Chan: 2 ←

Move the cursor under the channel number and click and then rotate the Select switch to increment the channels. Click the Select switch to set the desired channel, and then use the back arrows to exit the menus and resume measurements. Sampling will be performed on the selected channel until the user specifies a new manual setting or chooses automatic sampling.

The **Max** submenu enables the user to specify the number of channels to be sampled (minimum=2; maximum=3 for the Model 106-M-MC3 and maximum=6 for the Model 106-M-MC6). Sampling will be done sequentially from Channel 1, so be sure to connect your chosen number of sample lines accordingly.

Note that if the user wishes to sample only 1 channel, the **Manual** setting discussed above should be used.

To prevent damage to the instrument's internal pump, we recommend that unused inlets remain unobstructed/uncapped. That way, the user cannot inadvertently begin sampling from a port that is obstructed.

D.6.3 Other LCD Menu Functions

The other aspects of the LCD Menu are identical to the single-channel Model 106-M. Please refer to the appropriate parts of Section 3 of this manual.

D.7 Relays

The Multi-Channel Model 106 has four relays available (Figure D-5). Each of these can be used to respond to ozone for Channels 1, 2, 3, and 4 respectively. Additionally, Relay 2 can be used as a diagnostic of instrument parameters (temperature, pressure, lamp voltage, flow). The relays switch if measurements from any channel meet the criteria (i.e., they provide a global alarm). See Section 3.18 of the main manual for a description of the relays and Section D.8 below for serial menu operation of the Multi-Channel relays. Relay operation is also described in our Technical Note 045, available on our website (https://2btech.io/wp-content/uploads/docs/tech_notes/TN045.pdf).

D.8 Using the Serial Connection

Data may be displayed to a computer using pins 1, 2, and 3 of the 8-pin connector (inside of the instrument; see Figure D-5). Route connecting wires through the power/serial/relays port (red arrow). See the Industrial Installation Manual for details on the serial connections:

[Model 106 Industrial Installation Manual with Drawings](#)

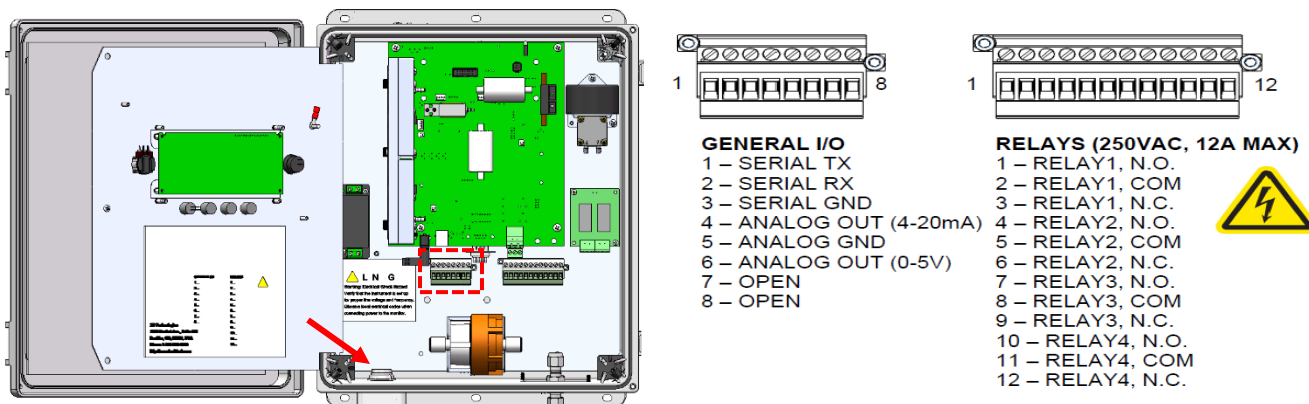

Figure D-5. Serial connections and analog connections (red dashed box) and relay connections (red solid box) to the Multi-Channel 106. Route connecting wires through the power/serial/relays port (red arrow).

Instructions for establishing connections to the computer are the same as the single-channel instrument; please refer to Sections 3.12.1 and 3.12.2 of this manual. Logged data may also be transmitted to a computer using the serial connection. See Section 3.14 of this manual for information.

In the multichannel instruments, the comma-delimited data line gives OZ_CH1, OZ_CH2, OZ_CH3, OZ_CH4, OZ_CH5, OZ_CH6, cell temperature, cell pressure, air

flow rate, photodiode voltage, channel currently being sampled, date, and time. Except for the channel currently being sampled, the “OZ_CHx” values will repeat the most recent averages for those channels. For a 6-channel instrument that is currently sampling Channel 4, an example data line is:

4.08,3.74,9.02,3.89,1.79,9.30,31.1,852.2,780,1.2741,4,27/09/20,16:38:56

where

4.08 ppm = last average for Channel 1 (in the user’s specified units)
3.74 ppm = last average for Channel 2
9.02 ppm = last average for Channel 3
3.89 ppm = latest individual measurement of Channel 4
1.79 ppm = last average for Channel 5
9.30 ppm = last average for Channel 6
31.1 °C = cell temperature (in the user’s specified units)
852.2 mbar = cell pressure (in the user’s specified units)
780 cc/min = air flow rate (volumetric)
1.2741 V= photodiode voltage
4 = channel currently being sampled
Sept. 27, 2020 = date
4:38:56 pm = time

If logging has been selected, the line will begin with the log number, for example:

221,4.08,3.74,9.02,3.89,1.79,9.30,31.1,852.2,780,1.2741,4,27/09/20,16:38:56

where 221 is the log number.

Several instrument operation functions are available through the serial connection. During normal operation, commands can be sent using the terminal emulator set with the properties listed in the section of this manual entitled “Collecting Data over the USB or Serial Port in Real Time” (Section 3.12). Listed below are the lower-case letters that are commands for performing certain operations while the instrument continues to measure:

- l** Start logging and write over existing logged data
- t** Transmit logged data
- e** End logging
- h** Output serial data line header
- m** Serial menu

If the letter **m** is sent as a command, **menu>** will be displayed in the terminal emulator window.

When the serial menu is accessed, the instrument is no longer making measurements; it is waiting for the next command to be entered.

The following is the list of serial commands accessible from this point:

Menu Commands: Serial Port

- l** Start logging and write over existing logged data (also available during measurements).
- t** End logging and transmit data (also available during measurements).
- e** End logging (also available during measurements).
- h** Output the serial header (also available during measurements).
- a** Set averaging time: enter a number followed by carriage return (0 = 10 s, 1 = 1 min, 2 = 5 min, 3 = 1 hour).
- z** Set the zero offset calibration factor: displays current setting and waits for a new setting followed by carriage return (enter setting in ppb [integers only]).
- s** Set the slope calibration factor: displays current setting and waits for a new setting followed by carriage return.
- c** Set the time and date
 - n** To exit without changing date or time
 - d** Asks to enter date in DDMMYY format
 - t** Asks to enter time in HHMMSS format.
- Y** Set all configuration to default.*
- B** Set to Auto mode.
- M** Set to Manual mode.
- b** Set the Auto mode measurement duration time.
- i** Set the Auto mode dwell time.
- k** Set manual channel.
- m** Set the number of ozone channels to use (1-6 or 1-3).
- n** Output instrument serial number.
- p** Perform Lamp test.
- o** Change relay 2 operation for diagnostics (Temp, Press, Flow, PDV).
 - 1** Enable temperature inclusion for relay 2.
 - !** Disable temperature inclusion for relay 2.
 - 2** Enable pressure inclusion for relay 2.
 - @** Disable pressure inclusion for relay 2.
 - 3** Enable flow inclusion for relay 2.
 - #** Disable flow inclusion for relay 2.
 - 4** Enable pdv inclusion for relay 2.
 - \$** Disable pdv inclusion for relay 2.
- q** Change relay 2 operation for Ozone.
- L** Set to flat temperature sensor (*do not adjust; this is a factory setting*)
- T** Set to round temperature sensor (*do not adjust; this is a factory setting*)
- ?** Output this help menu.
- x** Exit the serial menu.

* Default settings for the multi-channel instruments: Avg=10 s, offset=0, slope=1, T in °C, P in mbar, O₃ in ppb, auto sampling mode, duration=6 measurements, dwell=10 s, max channels=maximum number (3 or 6), manual channel=1, serial number resets to 1000 when command **Y** is executed. To reset to original serial number, use command **r** and password **bould**.

D.9 LED Indicator Lights

Four indicator lights are on the front instrument panel. From left to right:

- The far-left light indicates the ozone level is above 100 ppb. If the Monitor is sampling ambient air, personnel in the vicinity should take precautions to avoid breathing unsafe levels of ozone.
- The Low Flow indicator comes on if the flow rate is less than 0.4 L/min. This indicates that there could be leaks, or that the air pump needs replacing. See the Maintenance/Troubleshooting Section of this manual (Section 4).
- The Low Lamp indicator comes on if the lamp voltage drops below 0.6 volts, indicating that a lamp test should be conducted (Section 3.19) and that the lamp may need replacement and/or the flow path may need cleaning.
- The Power indicator is on the far right. It will always be on during normal operation.

D.10 Other Aspects Regarding Operation of the Multi-Channel Model 106-M

Except as noted in Appendix D above, and described in the list below below, operation of the multi-channel configuration of the Model 106-M is identical to the single-channel standard configuration of the instrument. Please refer to Section 3 of this manual.

- The same units settings for temperature, pressure, and ozone are used for all channels of the multi-channel instrument. See Section 3.9.
- The same calibration parameters are applied to all channels.
- The relays switch if measurements from any channel meet the criteria (i.e., they provide a global alarm). See Section 3.18 for a description of relay operation. Relay operation is also described in our Technical Note 045, available on our website (https://2btech.io/wp-content/uploads/docs/tech_notes/TN045.pdf).
- The USB output is not active on the multi-channel instrument. A serial to USB converter is provided with the instrument to enable USB connection.
- Analog output is not adjustable in the multi-channel instrument.

D.11 Maintenance/Troubleshooting, Calibration, and Zero/Span Checks

The descriptions found in Sections 4, 5, and 6 of this manual apply to the multi-channel configurations, Model 106-M-MC3 and Model 106-M-MC6.

Additional notes in the case of maintenance of the multi-channel instruments are:

- The inlet filter located inside the instrument (Figure D-7 below) should be changed approximately every 1 to 3 months of operation of the instrument, depending on the particulate loading of the air being sampled. If using external prefilters on the individual sample lines, this frequency may be reduced.

Full calibration at least annually is recommended. 2B Technologies provides calibration service. Alternatively, the user may perform the calibration. Section 5 of this manual provides guidelines for calibration. Periodic zero and span checks are recommended. See Section 6 of this manual.

D.12 Labeled Instrument Photos



Figure D-6. Front and bottom views of the Model 106-M-MC6 Multi-Channel Ozone Monitor.

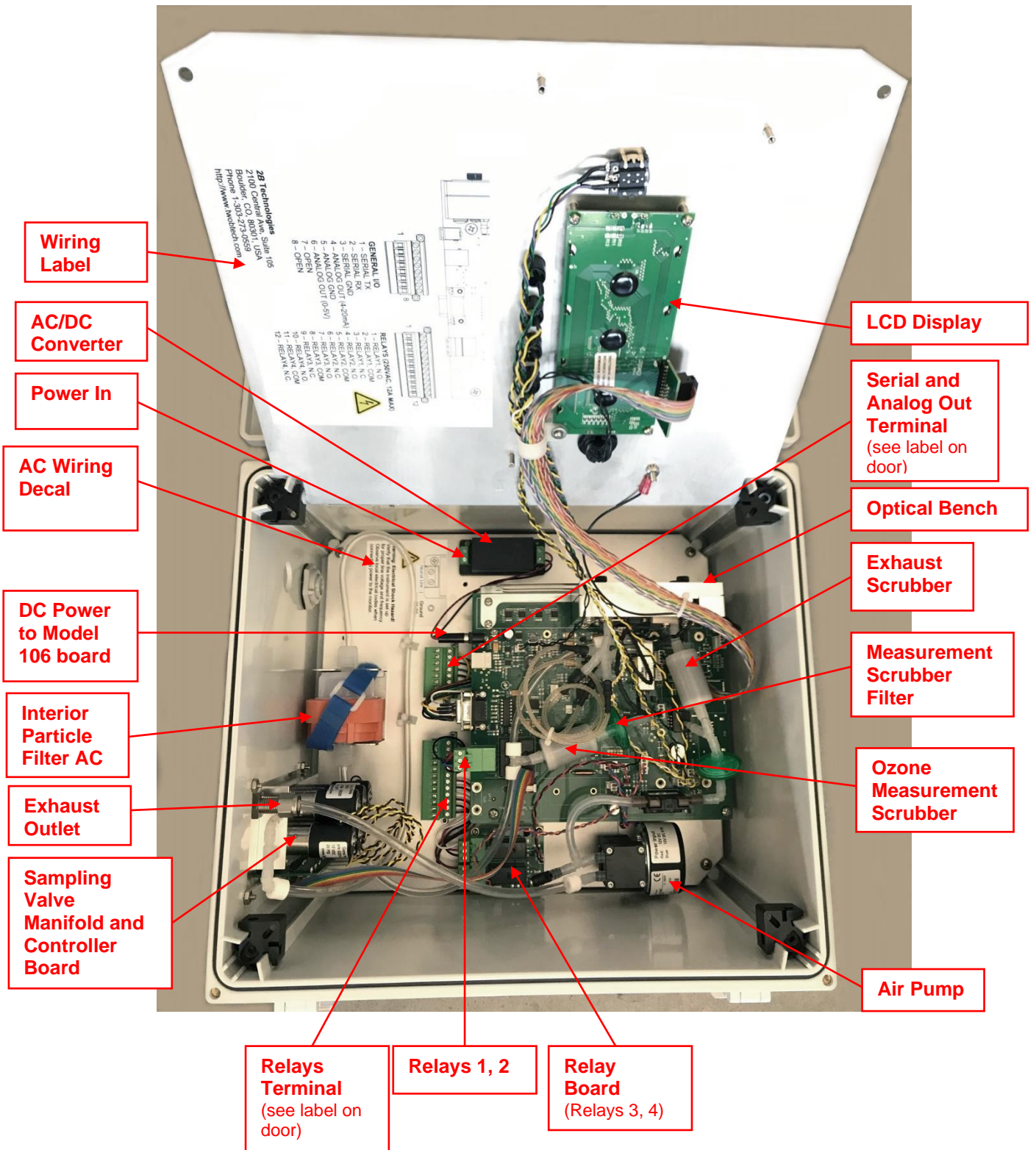

Figure D-7. Full open view of the Model 106-M-MC6 Ozone Monitor. See Figures 7.1a and 7.1b of this manual for a better view of the analogous components.

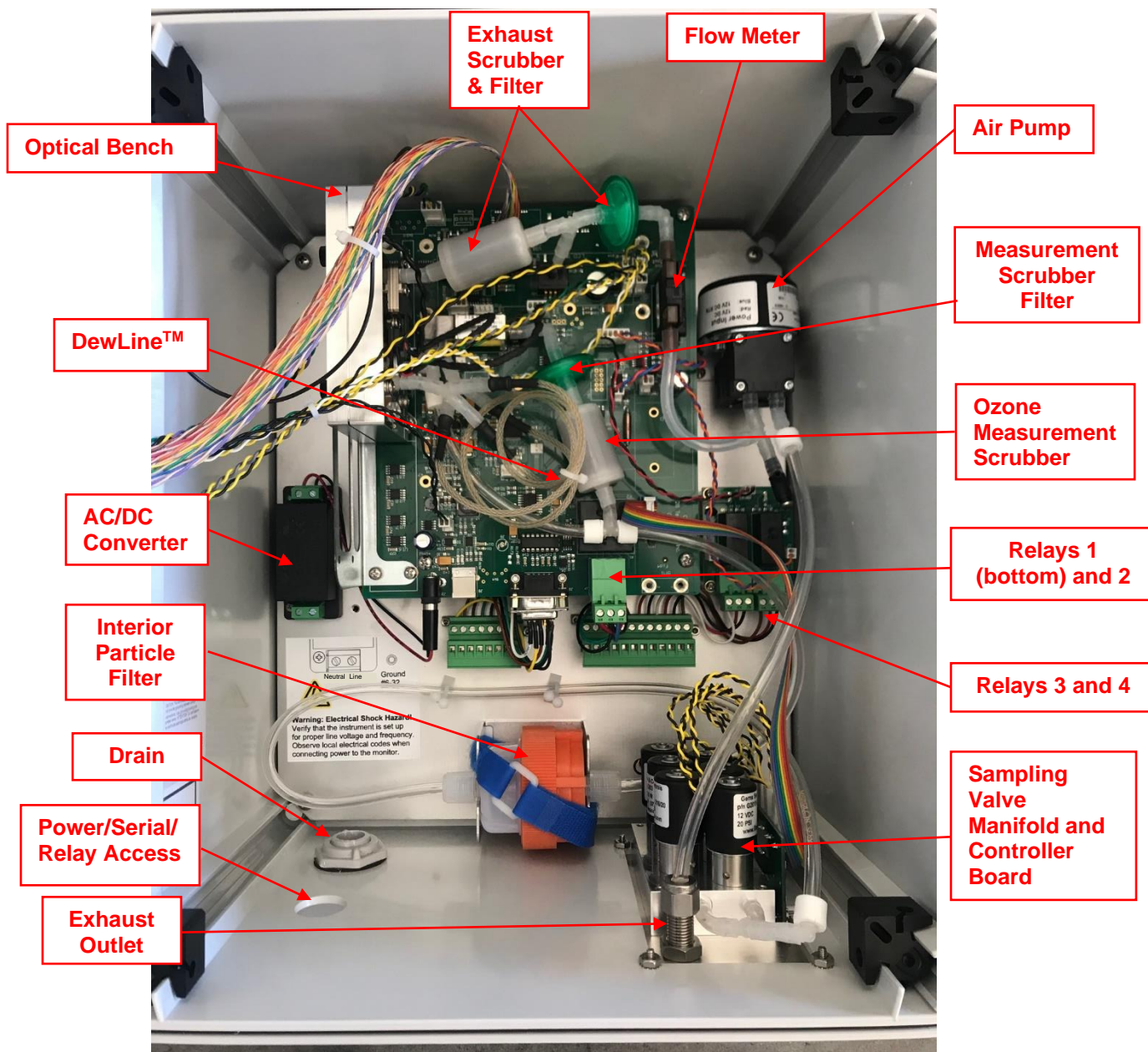

Figure D-8. Top inside view of the Model 106-M-MC6 Multi-Channel Ozone Monitor. See Figures 7.1a and 7.1b of this manual for a better view of the analogous components.

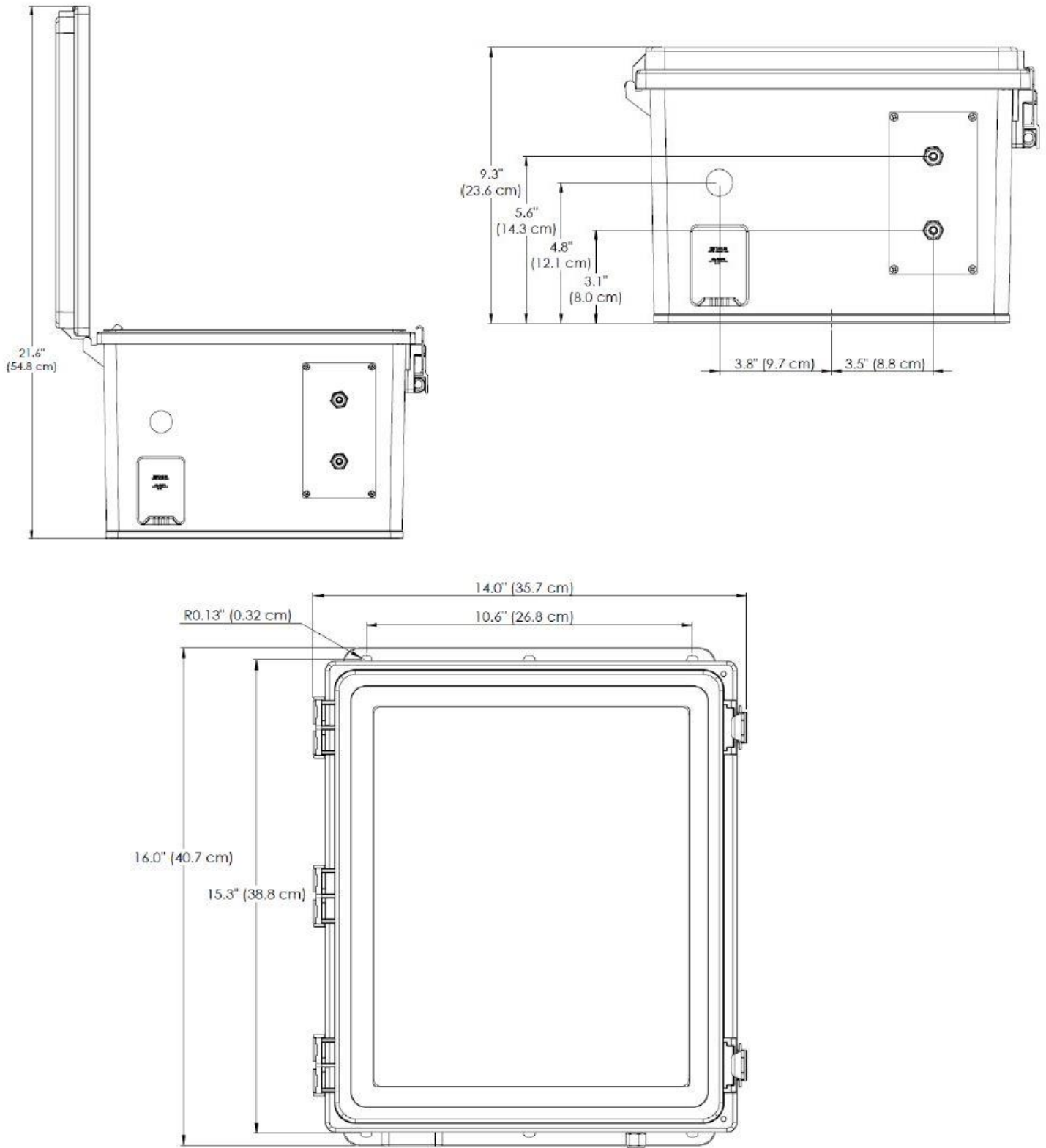

Figure D-9. Enclosure Dimensions of the Model 106-M-MC3 and Model 106-M-MC6 Multi-Channel Ozone Monitors.

Appendix E: Mounting the OEM Model 106 Ozone Monitor

The circuit board has four holes for mounting the ozone monitor to standoffs below the instrument (Figure E-1). The holes are for #6 machine size screws. Use insulating screws and washers to mount the instrument if mounting to something that is not grounded, otherwise use stainless steel screws and washers for three of the holes, and a plastic washer for the hole by the select switch (see below).

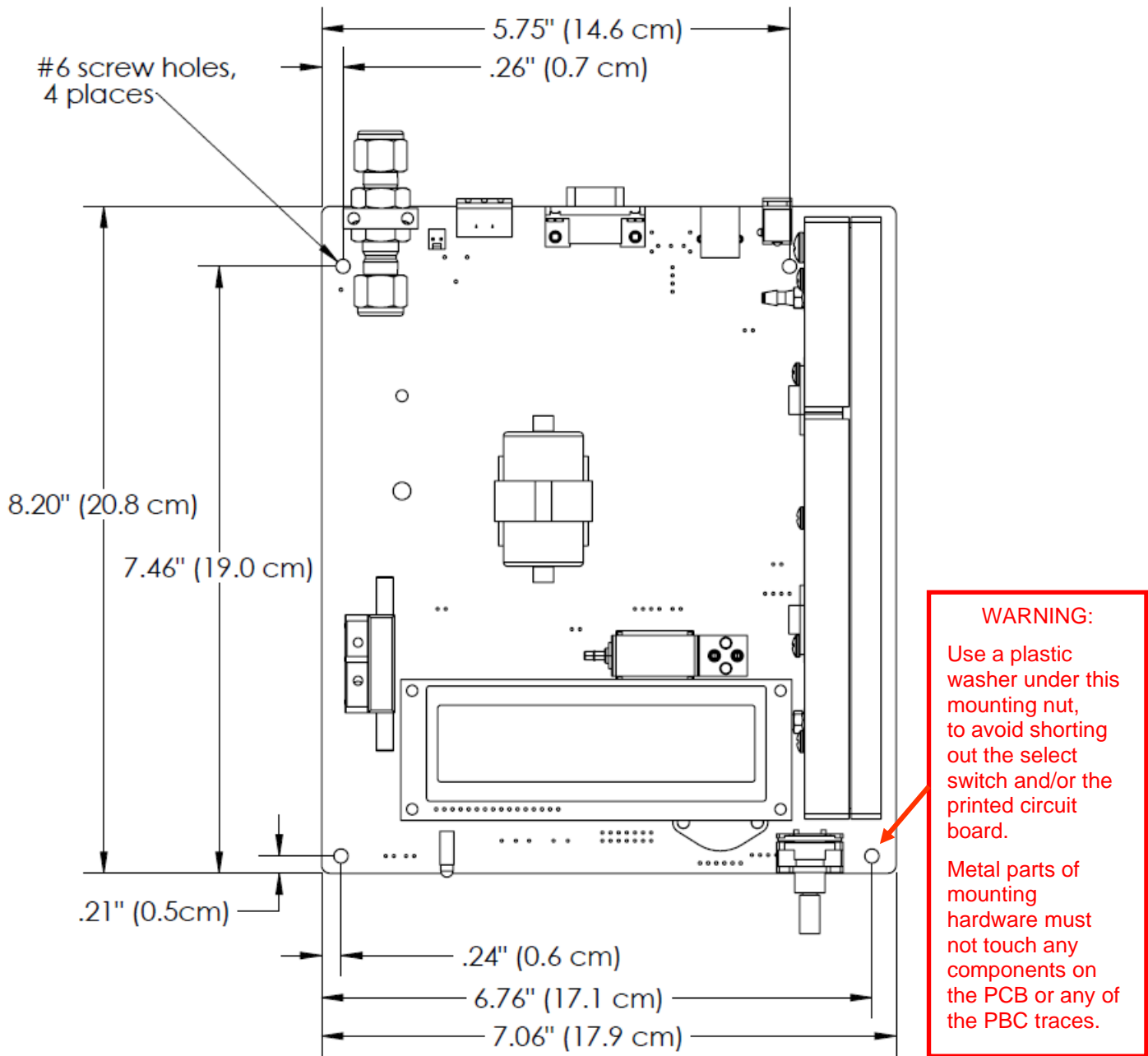

Figure E-1. OEM Dimensions and Mounting Holes (Top View).